

READ FIRST



Do not operate this machine until you read and understand all the dangers, warnings and cautions in this manual.

PLEASE READ THE ENTIRE CONTENTS OF THIS MANUAL PRIOR TO INSTALLATION AND OPERATION. BY PROCEEDING YOU AGREE THAT YOU FULLY UNDERSTAND AND COMPREHEND THE FULL CONTENTS OF THIS MANUAL. FORWARD THIS MANUAL TO ALL OPERATORS. FAILURE TO OPERATE THIS EQUIPMENT AS DIRECTED MAY CAUSE INJURY OR DEATH.

Rev. D1 12-05-22

INSTALLATION AND OPERATION MANUAL

MODELS:
RL-8500
RL-8500XLT
COMBINATION
BRAKE LATHE

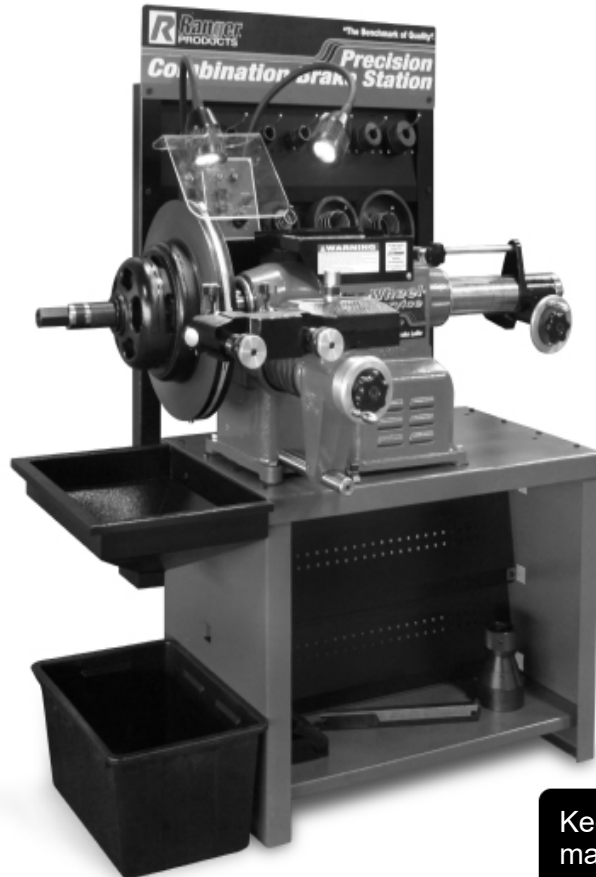

FOR RESURFACING
AUTOMOBILE
AND LIGHT TRUCK DRUMS,
ROTORS
AND FLYWHEELS

Keep this operation manual near the machine at all times. Make sure that ALL USERS read this manual.

SHIPPING DAMAGE CLAIMS

When this equipment is shipped, title passes to the purchaser upon receipt from the carrier. Consequently, claims for the material damaged in shipment must be made by the purchaser against the transportation company at the time shipment is received.

BE SAFE

Your new Ranger brake lathe was designed and built with safety in mind. However, your overall safety can be increased by proper training and thoughtful operation on the part of the operator. DO NOT operate or repair this equipment without reading this manual and the important safety instructions shown inside.



1645 Lemonwood Dr.
Santa Paula, CA. 93060, USA
Tel: 1-805-933-9970
Toll Free 1-800-253-2363
Fax: 1-805-933-9160
www.rangerproducts.com

RL-8500 COMBINATION BRAKE LATHE

RECORD HERE THE FOLLOWING INFORMATION WHICH IS LOCATED ON THE SERIAL NUMBER DATA PLATE

Model No.	
Revision	
Serial No.	
Date of Mfg.	
Voltage	

PURCHASE RECORD

Purchased Through (Distributor) _____

Distributor Address _____

Distributor Phone _____

RANGER RL-8500 BRAKE LATHE STANDARD FACTORY WARRANTY

TERMS

Ranger Products warrants each new RL-8500 Brake Lathe to be free from defects in material and workmanship for a period of 12 months from the date of purchase to the original equipment owner under normal use and service. The labor and service call charges to correct a factory manufacturing defect is covered by this warranty for a period of 90 days. Brake Lathe accessory items are warranted to be free from defects in material and workmanship for a period of 90 days including labor and service call charges.

THESE WARRANTIES DO NOT EXTEND TO...

defects caused by ordinary wear, abuse, misuse, shipping damage, improper installation or lack of required maintenance. This warranty is exclusive and in lieu of all other warranties expressed or implied. In no event shall Ranger Products be liable for special, consequential or incidental damages for the breach or delay in performance of the warranty. Ranger Products reserves the right to make design changes or add improvements to its product line without incurring any obligation to make such changes on product sold previously. Warranty adjustments within the above stated policies are based on the model and serial number of the equipment. This data must be furnished with all warranty claims.

DISCLAIMER OF CONSEQUENTIAL DAMAGES

Ranger Products shall not be liable for consequential damages arising out of or in connection with its products. Consequential damages shall include, without limitation, loss of use, income, or profit, loss sustained as the result of injury (including death) to any person, or loss of or damage to property (including property handled, processed or tested by our products).

NOTE: The equipment registration card must be completed and returned to the factory for warranty to be valid.

**THE INFORMATION ABOVE MUST BE PROVIDED
FOR ALL SERVICE AND WARRANTY CLAIMS**

TABLE OF CONTENTS

Warranty 2
 Owner's Responsibility 4
 Definitions of Hazard Levels 4
 Warning Instructions 5
 Before You Begin 5
 Electrical Requirements 5
 Important Safety Instructions 6
 RL-8500 Features 7
 RL-8500 Specifications 7
 RL-8500XLT Features 8
 RL-8500XLT Specifications 8
 Location/RL-8500 Tooling Package 9
 Optional Truck Adapter/RL-8500XLT Tooling Package 10
 Assembly View 11
Overview
 Step 1 - Installation 12
 Step 2 - Basic Set Up 13
 Step 3 - Basic Operation 14
 Step 4 - Brake Rotor/Drum Inspection 15
 Step 5 - Mounting the Quick Change Adapter 16
 Set Up Configuration Guide 17
Rotors
 Step 6 - Reconditioning Brake Rotors 18
 Step 7 - Mounting the Rotor 20
 Step 8 - Making the Rotor Scratch Cut 21-22
 Step 9 - Machining the Rotor 23-24
 Step 10 - Mounting a Composite Rotor 25-26
Drums
 Step 11 - Boring Bar Set Up (Drum) 28
 Step 12 - Drum Mounting 28-29
 Step 13 - Making the Drum Scratch Cut 30-31
 Step 14 - Machining the Drum 32-33
Flywheel
 Step 15 - Boring Bar Set Up (Flywheel) 34
 Step 16 - Mounting the Flywheel 34-35
 Step 17 - Scratch Cut on The Flywheel 35-36
 Step 18 - Machining the Flywheel 37-38
Maintenance
 Step 19 - Spindle Speed Adjustment 39
 Step 20 - Feed Motors Belt Replacement 40-41
 Step 21 - Maintenance 42-43
 Parts Listing / Motor Feed Assembly 44-45
 Parts Listing / Drum Feed Assembly 46-47
 Parts Listing / Crossfeed Assembly 48-49
 Parts Listing / Main Motor 50-51
 Parts Listing / Spindle Assembly 52-53



Failure to follow danger, warning, and caution instructions may lead to serious personal injury or death to operator or bystander or damage to property.

Do not operate this machine until you read and understand all the dangers, warnings and cautions in this manual.

For additional copies or further information, contact:
 BendPak Inc. / Ranger Products
 1645 Lemonwood Dr.,
 Santa Paula, CA. 93060
 1-805-933-9970
 www.bendpak.com



OPERATOR PROTECTIVE EQUIPMENT

Personal protective equipment helps make resurfacing safer. However, equipment does not take the place of safe operating practices. Always wear durable work clothing during service activity. Shop aprons or shop coats may also be worn, however loose fitting clothing should be avoided. Tight fitting leather gloves are recommended to protect operator's hands when handling brake parts. Sturdy leather work shoes with steel toes and oil resistant soles should be used by all service personnel to help prevent injury in typical shop activities. Eye protection is essential during rotor resurfacing. Safety glasses with side shields, goggles, or face shields are acceptable. Back belts provide support during lifting activities and are also helpful in providing operator protection. Consideration should also be given to the use of hearing protection if brake service activity is performed in an enclosed area, or if noise levels are high.



THIS SYMBOL POINTS OUT IMPORTANT SAFETY INSTRUCTIONS WHICH IF NOT FOLLOWED COULD ENDANGER THE PERSONAL SAFETY AND/OR PROPERTY OF YOURSELF AND OTHERS AND CAN CAUSE PERSONAL INJURY OR DEATH. READ AND FOLLOW ALL INSTRUCTIONS IN THIS MANUAL BEFORE ATTEMPTING TO OPERATE THIS MACHINE.

DEFINITION OF HAZARD LEVELS

Identify the hazard levels used in this manual with the following definitions and signal words:



DANGER

Watch for this symbol: It Means: Immediate hazards which will result in severe personal injury or death.



WARNING

Watch for this symbol: It Means: Hazards or unsafe practices which could result in severe personal injury or death.



CAUTION

Watch for this symbol: It Means: Hazards or unsafe practices which may result in minor personal injury or product or property damage.



Watch for this symbol! It means BE ALERT!
Your safety, or the safety of others, is involved!

OWNER'S RESPONSIBILITY

To maintain machine and user safety, the responsibility of the owner is to read and follow these instructions:

- ◆ Follow all installation instructions.
- ◆ Make sure installation conforms to all applicable Local, State, and Federal Codes, Rules, and Regulations; such as State and Federal OSHA Regulations and Electrical Codes.
- ◆ Carefully check the unit for correct initial function.

- ◆ Read and follow the safety instructions. Keep them readily available for machine operators.
- ◆ Make certain all operators are properly trained, know how to safely and correctly operate the unit, and are properly supervised.
- ◆ Allow unit operation only with all parts in place and operating safely.
- ◆ Carefully inspect the unit on a regular basis and perform all maintenance as required.
- ◆ Service and maintain the unit only with authorized or approved replacement parts.
- ◆ Keep all instructions permanently with the unit and all decal's on the unit clean and visible.



Before using this brake lathe, **ALWAYS** assume that all brake rotors, brake drums, and flywheels have residual asbestos particles that may become airborne. Exposure to asbestos, if not properly controlled can cause lung disease and mesothelioma, a cancer of the lining of the lung or stomach that is nearly always fatal. Failure to utilize proper brake dust control procedures may result in increased asbestos exposure. ALWAYS ensure that all operators using this equipment wear appropriate personal protective equipment such as, but not limited to: respiratory protective equipment; disposable coveralls or similar full-body disposable work clothing; gloves, head coverings, and foot coverings; and face shields, vented goggles, or other appropriate personal protective equipment.

For more information, visit:

- <https://www.epa.gov/sites/default/files/documents/brakebrochure-paginated.pdf>
- <https://www.epa.gov/asbestos>
- <https://www.osha.gov/laws-regs/regulations/standardnumber/1910/1910.1001AppF>

Failure to follow these warnings can result in serious injury or death.



WARNING INSTRUCTIONS

1. This equipment incorporates parts such as electrical switches which tend to produce sparks. When located in a service facility, the unit should be in a ventilated room or enclosure provided for the purpose, or should be at least 18 inches or more above floor to minimize the risk of igniting fuel vapors.
2. Eye and face protection is required and strongly recommended: "Protective eye and face equipment is required to be used where there is a reasonable probability of injury that can be prevented by use of such equipment." OSHA 1910.133 (a) Protective goggles, safety glasses, or a face shield must be provided by the purchaser/user and worn by the operator of the equipment. Make sure all eye and face safety precautions are followed by the operator(s). Keep bystanders out of the area.
3. Do not remove any safety equipment such as guards, control switches or shut-off devices.
4. Make sure rotors/drums/flywheels are properly mounted and square before starting the lathe. Check to make sure all parts are secure.
5. Make sure the rotors/drums/flywheels are clean and mounted properly before operating lathe.
6. Do not overload the lathe. Read and understand the lathe capabilities prior to operation. Overloading the lathe shortens the life of the unit, and could cause a failure resulting in personal injury.
7. Check damaged parts carefully. Before further use of the lathe, a guard or other part that is damaged should be carefully checked. Immediately replace all damaged, missing, or non-functional parts. Check for alignment of moving parts, binding of moving parts, breakage of parts, mounting, and any other conditions that may affect operation. Guards and other parts that are damaged should be properly repaired or replaced before lathe is used again.
8. Always feed the blade or cutter into the work and against the direction of rotation. Cutters and tool bits are designed to begin the cut from near the center of the rotor/drum/flywheel to the outer edge. Do not attempt to cut from the outside edge into the center.
9. Never leave the brake lathe running unattended. Turn the power off. Don't leave the brake lathe until the power switch is turned to the OFF position.
10. Never use compressed air to blow and clear chips. Chips and dust may be driven between machined parts and into bearings, causing undue wear. They may also contact persons in the area causing personal injury.

BEFORE YOU BEGIN

Receiving:

The shipment should be thoroughly inspected as soon as it is received. The signed bill of lading is acknowledgement by the carrier of receipt in good condition of shipment covered by your invoice. If any of the goods called for on this bill of lading are shorted or damaged, do not accept them until the carrier makes a notation on the freight bill of the shorted or damaged goods. Do this for your own protection.

NOTIFY THE CARRIER AT ONCE if any hidden loss or damage is discovered after receipt and request the carrier to make an inspection. If the carrier will not do so, prepare a signed statement to the effect that you have notified the carrier (on a specific date) and that the carrier has failed to comply with your request.

IT IS DIFFICULT TO COLLECT FOR LOSS OR DAMAGE AFTER YOU HAVE GIVEN THE CARRIER A CLEAR RECEIPT. File your claim with the carrier promptly. Support your claim with copies of the bill of lading, freight bill, invoice, and photographs, if available. Our willingness to assist in helping you process your claim does not make Ranger Products responsible for collection of claims or replacement of lost or damaged materials.

ELECTRICAL REQUIREMENTS

THIS UNIT CAN BE POWERED WITH 110 VOLTS OR 220 VOLTS. THE VOLTAGE SELECTOR SWITCH MUST BE SET PRIOR TO OPERATION ! SEE PAGE 10 FOR SWITCH LOCATION.

For 110 Volt operation, this unit requires power from a 15 amp 110 volt circuit. The lathe must be properly grounded to protect the operator from shock. The RL-8500 is equipped with an approved power cord and 3-prong grounding-type plug. Should an extension cord be required, be sure to use a similar size power cord with 3-prong grounding plug and a 3-prong grounding receptacle properly rated to handle the electrical requirement of this unit. Do not modify a cord or plug to match a receptacle; have a qualified electrician install an appropriate outlet to match the lathe requirements. Repair or replace any worn or damaged power cords immediately.



IMPORTANT NOTE !

For 220 volt operation it will be necessary to replace the 110 volt 3-prong plug with an appropriate 220 volt 3-prong plug with ground. After changing the plug, position the voltage selector switch on the underside of the unit to the 220 setting. Verify that the lathe plug and grounding-type receptacle match. All wiring must be performed by a licensed electrician.

IMPORTANT SAFETY INSTRUCTIONS !

Before operating the lathe, review the warning information on the lathe and the cautions, warnings and dangers in this manual. Also review the following general safety instructions.

When using your brake lathe basic safety precautions should always be followed, including the following:

- ◆ **KEEP GUARDS IN PLACE** and in working order.
- ◆ **KEEP HANDS** clear of moving parts at all times. Keep hair, loose clothing, neckties, shop rags, jewelry, fingers, and all parts of body away from moving parts.
- ◆ **ALWAYS USE SAFETY GLASSES.** Everyday eyeglasses only have impact resistant lenses, they are NOT safety glasses. Safety glasses, goggles, or a face shield will help protect the operator from injury. Use a face shield and dust mask during all operations.
- ◆ **SECURE WORK** properly for setup and tool bit positioning before attempting to make first cut. Do not attempt to touch rotors, drums and flywheels with your hands with the lathe in operation.
- ◆ **REMOVE ADJUSTING KEYS AND WRENCHES** from the lathe before turning it on.
- ◆ **MAINTAIN TOOLS WITH CARE.** Keep tools sharp and clean for best and safest performance. Follow instructions for lubricating and changing accessories.
- ◆ **USE FACTORY APPROVED TOOLS ONLY.** Don't force a tool or an attachment to do a job for which it was not designed. The use of improper accessories may cause risk of injury to operator or bystanders. Use only as described in this manual. Use only manufacturer's recommended attachments.
- ◆ **KEEP WORK AREA CLEAN** and well lighted. Cluttered areas and benches invite accidents.
- ◆ **LOCATE POWER CORD SAFELY.** Do not let power cord come in contact with moving parts.
- ◆ **REDUCE RISK OF FIRE.** Do not operate equipment in near open containers of flammable liquids and their vapors.

- ◆ **PROVIDE ADEQUATE VENTILATION** when working on operating internal combustion engines. Vehicle exhaust must be vented from work area.

- ◆ **DRESS PROPERLY.** Keep hair, loose clothing, neckties, shop rags, jewelry, fingers, and all parts of body away from moving parts. Non-slip footwear is recommended.

- ◆ **ALWAYS UNPLUG EQUIPMENT** from electrical outlet when not in use. Never use the cord to pull the plug from the outlet. Grasp plug firmly and pull to disconnect.

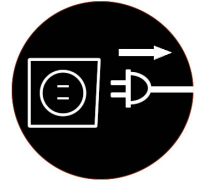

- ◆ **DO NOT TOUCH HOT PARTS.** Care must be taken as burns can occur from touching hot parts.

- ◆ **PROPERLY MAINTAIN EQUIPMENT.** Do not operate equipment with a damaged cord or if the equipment has been dropped or damaged—until it has been examined by a qualified serviceman.

- ◆ **REDUCE RISK OF SHOCK.** Do not use on wet surfaces or expose to rain.

- ◆ **KEEP CHILDREN/UNAUTHORIZED PERSONS AWAY.** All bystanders should be kept completely away from the work area.

- ◆ **REMOVE POWER AND DISCONNECT TOOLS** before servicing the unit and when changing accessories such as blades, bits, cutters, etc. Follow lock-out and tag-out procedures as required.

- ◆ **AVOID UNINTENTIONAL STARTING.** Make sure the switch is in the **OFF** position before plugging the machine in or performing any maintenance or service work.

- ◆ **NEVER LEAN OR STAND ON THE LATHE.** Serious injury could occur if the lathe is tipped over or if the cutting tool is unintentionally contacted.

IMPORTANT NOTICE !

Do not attempt to operate this equipment if you have never been trained on basic brake lathe operation procedures.

Stay clear of moving parts that can cause injury. These instructions must be followed to insure proper installation and operation. Failure to comply with these instructions can result in serious bodily harm and void product warranty. Manufacturer will assume no liability for loss or damage of any kind, expressed or implied resulting from improper installation, operation or use of this product.

PLEASE READ ENTIRE MANUAL PRIOR TO INSTALLATION !

MODEL RL-8500 COMBINATION BRAKE LATHE

The Ranger RL-8500 Combination Brake Lathe is intended to resurface disc brake rotors, brake drums and flywheels on passenger cars, light duty and some medium duty trucks. Using this lathe for other purposes could result in personal injury and/or equipment damage.

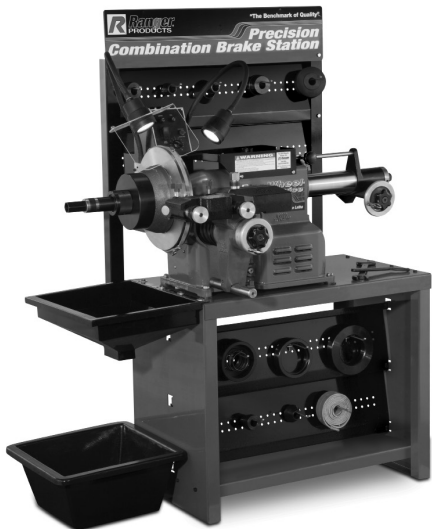

Cutting Edge Design Features:

- Rather than mechanically driven transmission and gear boxes, the RL8500 uses precision electric DC servo motors designed to meet the demanding requirements of industrial motion control.
- Our Quick Change Adapter Plus system eliminates the need for conventional bell clamps and cones and features built in springs so you don't lose them. Works on foreign and domestic car and truck hubless drums and rotors 2 5/32" to 4" center hole and composite rotors 4" to 6 1/4" center hole.
- The RL8500 is equipped with features that help increase your service capability, like precision twin cutter tools and a quick drum to rotor changeover.
- Infinitely variable spindle and cross feed speed settings allow for quick rough and precision finish cuts. Simple ergonomic controls are designed for minimal operator movement.
- The RL8500 maintains accuracy year after year thanks to rugged construction like a forged, hardened and precision ground spindle that resists grooving and eliminates the need for boots. Massive tapered spindle bearings offer superior weight support during rotation.
- Our exclusive "splash lube" oil feed system supplies a constant flow of oil to the bearings making sure they provide years of trouble free service.

- Serpentine belts provide a faster, quieter operation and reduce chatter and vibration.
- An independent cross feed motor eliminates the need for plastic or bronze shear gears which are expensive and timely to replace.
- A convenient top storage tray means your popular adapters and tools are kept within easy reach.
- Separate motors on the drum and rotor feed help maximize the main motor's efficiency.
- Our deluxe standard adapter package includes a Quick Change hubless adapter system that makes mounting rotors and drums quick and easy. A variety of adapters lets you machine all standard and composite rotors for foreign and domestic cars and light trucks. Optional truck adapter kit available.
- A 450 pound cast iron body and a solid work bench eliminates transient vibrations ensuring a smooth uninterrupted surface finish with each pass.
- Easily change arbor speeds in seconds. Choose 150 or 250 RPM depending on the job.
- Positive rake cutter tip angle provides for a one pass finish virtually every time.

SPECIFICATIONS:

	62" / 1,575 mm.
Floor Space - Width:	49" / 1,245 mm.
Floor Space - Depth:	36" / 914 mm.
Spindle To Floor - On Bench:	39 1/2" / 1,003 mm.
Electrical:	115/230 VAC, 50/60 Hz, 1-Phase, 20 Amps
Spindle Diameter	2 7/8" / 73.02 mm
Spindle Motor:	1 HP, 115/230 VAC, 50/60 Hz.
Spindle Travel:	6-7/8" / 175 mm.
Spindle Speed - Min:	150 RPM
Spindle Speed - Max:	200 RPM
Spindle Feed Infinitely Variable:	0 to .010" /Rev. / .25 Mm/Rev
Cross Feed Infinitely Variable:	0- .020" /Rev. / 0.50 Mm/Rev.
Maximum Rotor Diameter:	17" / 432 mm.
Maximum Rotor Thickness:	2 1/2" / 63.5 mm.
Drum Diameter - Min:	6" / 152 mm
Brake Drum Diameter - Max:	6-28" / 152mm-711 mm.
Maximum Load Standard Arbor	150Lbs. / 68Kg.
Maximum Load 1-7/8" Arbor	250Lbs. / 113Kg.
Shipping Weight - Complete	685 Lbs. / 310 kg.

MODEL RL-8500XLT HEAVY DUTY BRAKE LATHE

The Ranger RL-8500XLT Heavy Duty Combination Brake Lathe offers you more performance, more utility, more flexibility and more productivity than you've ever imagined.

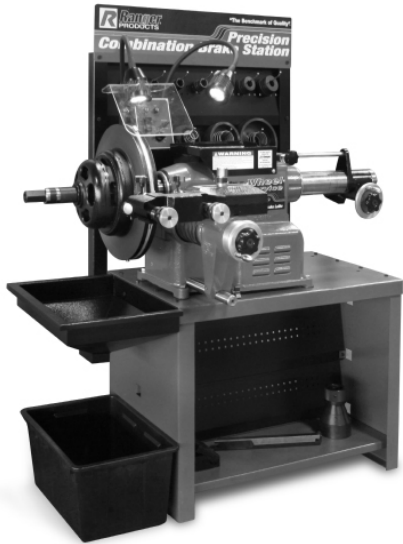

The RL-8500XLT provides these features:

- Extended capacity spindle can be used on brake drums 10" deep.
- Rear bushing location provides extra support for the arbor.
- Capable of truing even the heaviest drum rotors.
- In contrast to mechanically-driven transmission and gear boxes, the RL-8500XLT uses precision electric DC servo motors designed to meet the demanding requirements of industrial motion control.
- Quick-Change Adapter-Plus system with built-in springs eliminates the need for conventional bell clamps and cones.
- Works on most cars and trucks, both foreign and domestic, with hubless drums, rotors (center hole sized 2-5/32" – 4") and composite rotors (center hole sized 4" – 6-1/4").
- The RL-8500XLT is equipped with features that help increase your service capability, like precision twin cutter tools and a quick drum-to-rotor changeover. Infinitely variable spindle and cross feed speed settings allow for quick rough and precision finish cuts.
- Simple ergonomic controls are designed for minimal operator movement.
- Legendary control makes unit easy to learn and master.

- The RL-8500XLT maintains accuracy year after year thanks to ruggedly constructed components, like a hardened, precision ground spindle that resists grooving and makes boots a thing of the past.
- Massive tapered spindle bearings offer superior weight support during rotation.
- A 450 pound cast iron body and a solid work bench eliminates transient vibrations ensuring a smooth uninterrupted surface finish with each pass.
- An independent cross-feed motor eliminates the need for plastic or bronze shear gears which are expensive and time consuming to replace.
- Positive rake cutter tip angle provides for a one pass finish virtually every time, allowing you to complete your work faster than multi pass lathes.
- Our deluxe standard adapter package includes a Quick-Change hubless adapter system that makes mounting rotors and drums quick and easy.
- Easily change arbor speeds in seconds: choose 150 or 200 rpm, depending on the job.
- Optional truck adapter kit available.

SPECIFICATIONS:

Overall Height - On Bench:	62" / 1,575 mm.
Floor Space - Width:	49" / 1,245 mm.
Floor Space - Depth:	36" / 914 mm.
Spindle To Floor - On Bench:	39 1/2" / 1,003 mm.
Electrical:	115/230 VAC, 50/60 Hz, 1-Phase, 20 Amps
Spindle Diameter	2 7/8" / 73.02 mm
Spindle Motor:	1 HP, 115/230 VAC, 50/60 Hz.
Spindle Travel:	9-7/8" / 248 mm.
Spindle Speed - Min:	150 RPM
Spindle Speed - Max:	200 RPM
Spindle Feed Infinitely Variable:	0 to .010" /Rev. / .25 Mm/Rev
Cross Feed Infinitely Variable:	0- .020" /Rev. / 0.50 Mm/Rev.
Maximum Rotor Diameter:	17" / 432 mm.
Maximum Rotor Thickness:	2 1/2" / 63.5 mm.
Drum Diameter - Min:	6" / 152 mm
Brake Drum Diameter - Max:	6-28"/152mm-711 mm.
Maximum Load Standard Arbor	150Lbs./68Kg.
Maximum Load 1-7/8" Arbor	250Lbs./113Kg.
Shipping Weight - Complete	720 Lbs. / 327 kg.

EQUIPMENT LOCATION



Proper unit installation is necessary for safe use and efficient operation. Proper installation also helps protect the unit from damage and makes service easier. Always keep this manual nearby.

Location

Select a location that will provide the operator with enough space to use the equipment in a safe manner. The area selected should be well lit, easy to clean and should be away from oil, grease, etc. Avoid areas where bystanders and customers may be present.

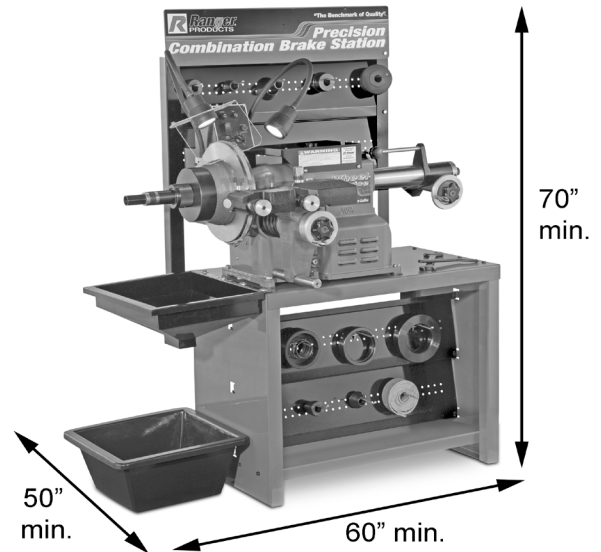

RL8500 STANDARD TOOLING PACKAGE

- (A) Quick-Change Adapter Plus System
- (B) Backing Plate 6.75"OD
- (C) Backing Plate 5.25"OD
- (D) Sm. Cup w/ Built-in-Spring 5.25"OD
- (E) Lg. Cup w/ Built-in-Spring 6.75"OD
- (F) Dbl. Tapered Collet 1.322" x 1.670"
- (G) Dbl. Tapered Collet 1.362" x 1.710"
- (H) Dbl. Tapered Collet 1.711" x 2.073"
- (I) Dbl. Tapered Collet 2.074" x 2.440"
- (J) Dbl. Tapered Collet 2.441" x 2.897"
- (K) Centering Cone 1.187" x 2.25"
- (L) Self-Aligning Spacer 1 5/8" long
- (M) Spacer 1/2" long
- (N) Spacer 2" long
- (O) Bell Clamp 4 1/4"OD
- (P) Step Adapter 1" x 2"
- (Q) Spring
- (R) Drum Silencer
- (S) Universal Silencer band
- (T) Large Wrench
- (U) Large Rubber Silencer
- (V) Small Rubber Silencer
- (W) Small Wrench
- (X) Spanner Wrench
- (Y) Arbor / Arbor Nut
- (Z) Twin Cutter Assembly
- (B1) Boring Bar Assembly

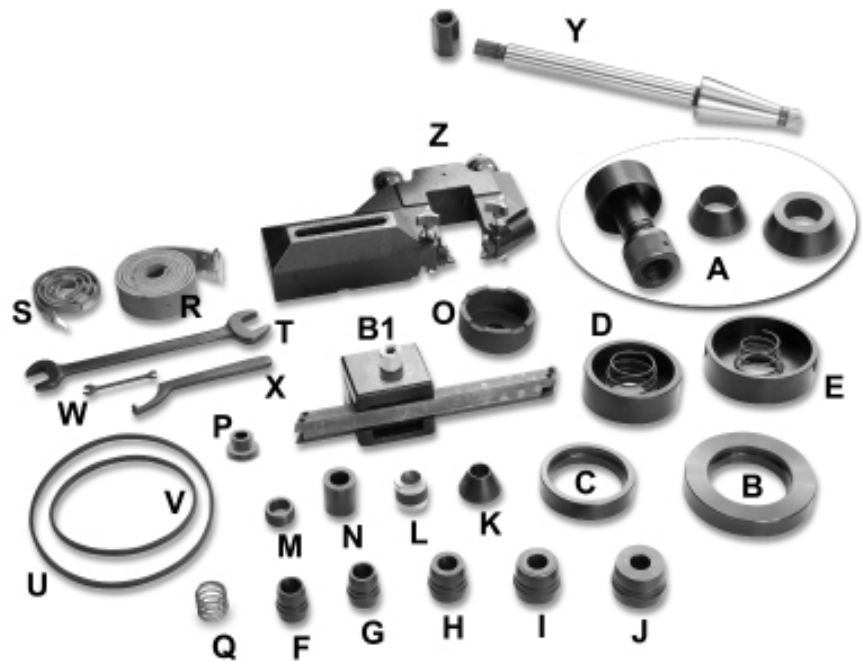

Arbor - 1-7/8" Arbor (Truck Rotors and Drums Up To 200 lbs.)
 Arbor Nut - 1 7/8"

**TRUCK ADAPTER KIT
 OPTIONAL**

- (A) Centering Cone 2.750" x 3.334" (69.05 x 84.67 mm)
- (B) Centering Cone 3.281" x 3.891" (83.34 x 98.83 mm)
- (C) Centering Cone 3.828" x 4.422" (97.23 x 112.32 mm)
- (D) Centering Cone 4.359" x 5.000" (110.72 x 127.00 mm)
- (E) Centering Cone 4.656" x 5.250" (118.26 x 133.35 mm)
- (F) Centering Cone 4.875" x 5.500" (123.83 x 139.70 mm)
- (G) Centering Cone 5.437" x 6.031" (138.10 x 153.18 mm)
- (H) Centering Cone 5.969" x 6.562" (151.61 x 166.67 mm)
- (I) Centering Cone 6.550" x 7.437" (166.37 x 188.90 mm)
- (J) Centering Cone 7.000" x 7.7001" (177.80 x 195.58 mm)
- (K) Centering Cone 7.578" x 8.172" (192.48 x 207.56 mm)
- (L) Spacer - 1.25" (31.75 mm) Long
- (M) Spacer - 2" (50.80 mm) Long
- (N) Bell Clamp 6.250"OD (158.75mm)
- (O) Bell Clamp 7.250"OD (184.14mm)
- (P) Bell Clamp 9.250"OD (234.95mm)
- (Q) Double Tapered Collet 2.828" x 3.185" (71.83 x 80.90mm)
- (R) Double Tapered Collet 3.203" x 3.560" (81.36 x 90.42mm)
- (S) Centering Cone 2.156" x 3.375" (54.76 x 85.72mm)
- (T) Spring

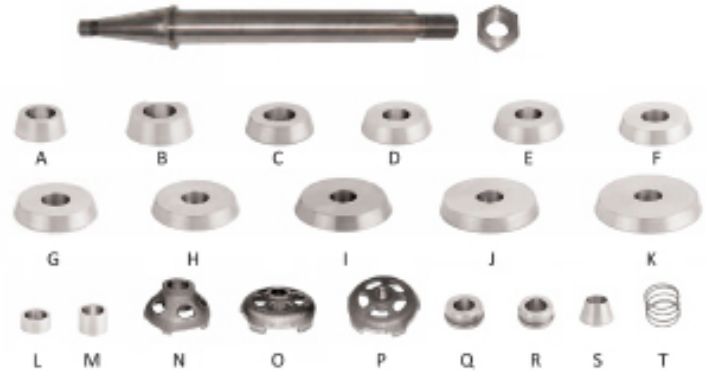

- (A) Quick-Change Adapter Plus System
- (B) Backing Plate 6.75"OD
- (C) Backing Plate 5.25"OD
- (D) Sm. Cup w/ Built-in-Spring 5.25"OD
- (E) Lg. Cup w/ Built-in-Spring 6.75"OD
- (F) Dbl. Tapered Collet 1.322" x 1.670"
- (G) Dbl. Tapered Collet 1.362" x 1.710"
- (H) Dbl. Tapered Collet 1.711" x 2.073"
- (I) Dbl. Tapered Collet 2.074" x 2.440"
- (J) Dbl. Tapered Collet 2.441" x 2.897"
- (K) Centering Cone 1.187" x 2.25"
- (L) Self-Aligning Spacer 1 5/8" long
- (M) Spacer 1/2" long
- (N) Spacer 2" long
- (O) Bell Clamp 4 1/4"OD
- (P) Step Adapter 1" x 2"
- (Q) Spring
- (R) Drum Silencer
- (S) Universal Silencer band
- (T) Large Wrench
- (U) Large Rubber Silencer
- (V) Small Rubber Silencer
- (W) Small Wrench
- (X) Spanner Wrench
- (Y) Arbor / Arbor Nut
- (Z) Twin Cutter Assembly
- (B1) Boring Bar Assembly
- (X1) Truck Backing Plate 7.40"/188mm
- (X2) Small Truck Cone 4.124" x 5.25" / 104.77mm x 133.35 mm
- (X3) Large Truck Cone 5.125" x 6.25" / 130.18 x 158.75mm
- (X4) Double Tapered Truck Collet 2.841" x 3.190" / 72.16 x 81.03mm
- (X5) Double Tapered Truck Collet 3.191" x 3.560" / 81.05 x 90.43mm

**RL8500XLT
 TOOLING PACKAGE**

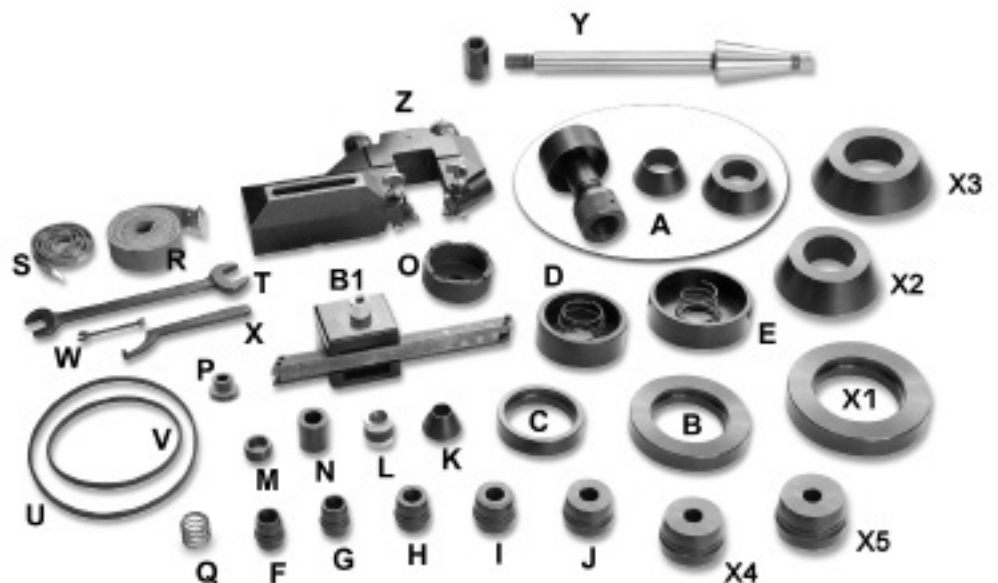

ASSEMBLY VIEW

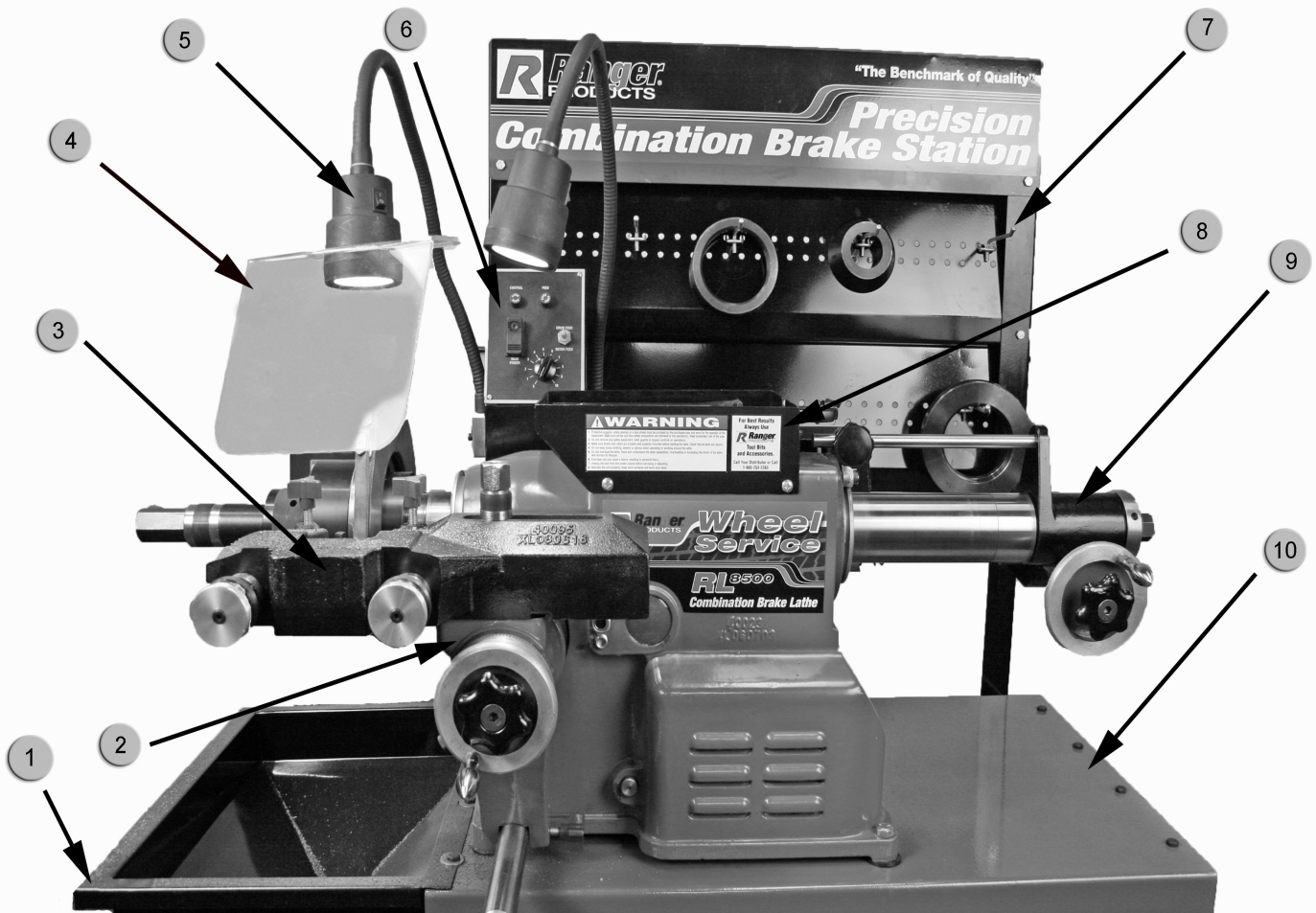

Item #	Description
1	Upper Chip Tray
2	Cross Feed Assembly
3	Twin Cutter Head
4	Plastic Shield Guard
5	Work Light (2)
6	Power Control Box
7	Upper Panel Assembly
8	Tool Tray
9	Spindle Assembly
10	Work Bench
-	Lower Panel Assembly
-	Lower Chip Tray

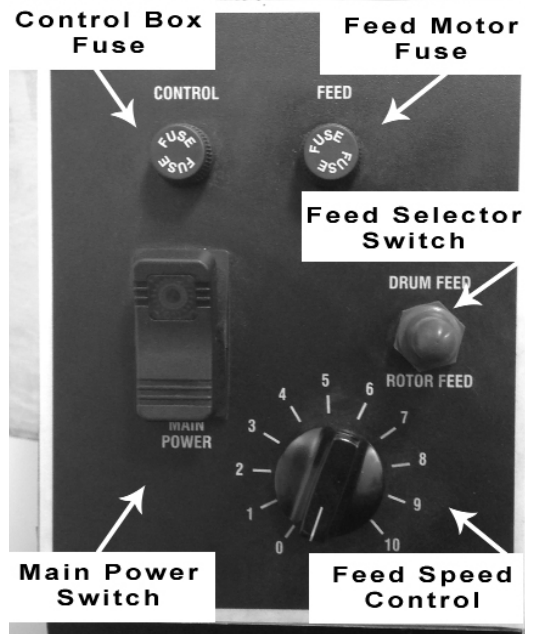

STEP 1 (Installation)

1. Assemble the Bench with Chip Tray as shown below. Tighten all fasteners securely.



NOTE:

THIS UNIT CAN BE POWERED WITH 110 VOLTS OR 220 VOLTS. THE LATHE IS SHIPPED WITH THE VOLTAGE SELECTOR SWITCH IN THE NEUTRAL POSITION. THE VOLTAGE SELECTOR SWITCH MUST BE SET PRIOR TO OPERATION !

5. Position the voltage selector switch in the proper position to match the power source.

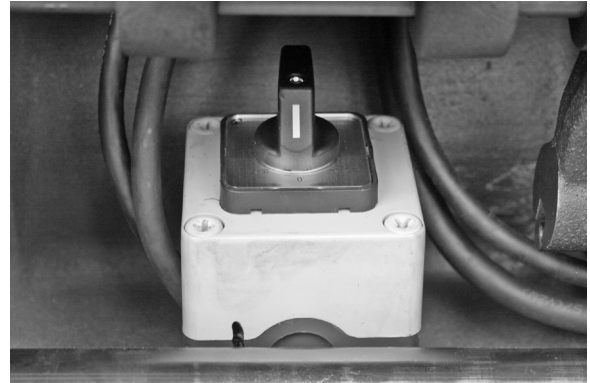

2. After assembly, the Bench should be leveled. The bench may be bolted down with 3/8" concrete bolts or lag screws (not provided.)

3. Unbolt the lathe from the shipping pallet and remove any packing materials and protective wrapping from the lathe and components.



Always follow safe lifting practices when lifting heavy loads. Use a forklift or crane only. Do not attempt to lift lathe unit onto the bench without the use of material handling equipment with a lifting capacity 400 pounds or greater.

ENSURE THAT THE DEVICES/ STRAPS / CHAINS USED TO SUPPORT THE LATHE WILL NOT MAR, SCRATCH OR DAMAGE THE SPINDLE.

4. Using a shop crane or other heavy lifting device WITH NON-MARRING STRAPS OR WRAPPED CHAINS CAPABLE OF SUPPORTING THE WEIGHT OF THE LATHE. Raise the lathe over the bench.

Before lowering the Lathe onto the bench Set the Voltage selector switch. The Voltage Selector switch is located inside the Lathe housing on the left / Cross Feed side of the Lathe.

6. Lower the Lathe onto the Bench. Bolt the Lathe to the Bench, ensure the rubber washers are installed between the lathe and the bench.

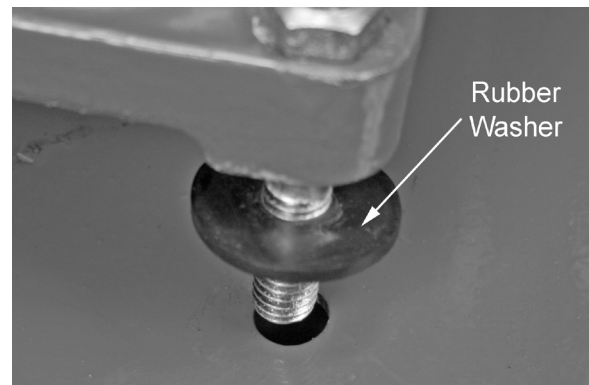

7. Install the Plastic Shield onto the Work Light Assembly.

8. Install the Peg Hooks. Mount accessories on peg hooks as desired.

STEP 2 (Basic Set Up)

1. Install the Long Arbor Bolt into the Spindle.
2. Install the Arbor into the right end of the Spindle. Check to make sure the alignment mark on the Arbor lines up with the mark on the Arbor Chuck.

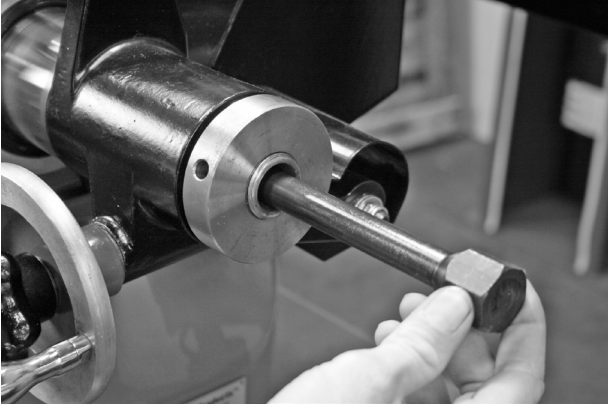

3. Hand tighten the Arbor Bolt. Double check the alignment of the Arbor with the tick mark in the Arbor Chuck. Tighten the Arbor Nut with the supplied wrench.

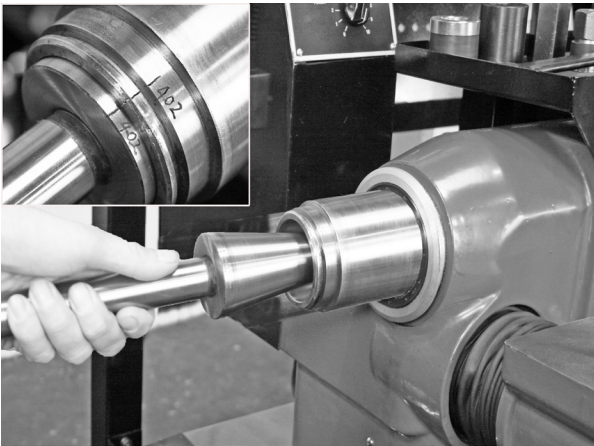

4. Install the Cutting Tips into the tool holders and the Tool Holders into the Cutting Assembly. Always extend the Tool Holders the minimum required to perform the cutting operation.



5. Install the Twin Cutting head on the Cross Feed base. Hand tighten the Lock Nut.

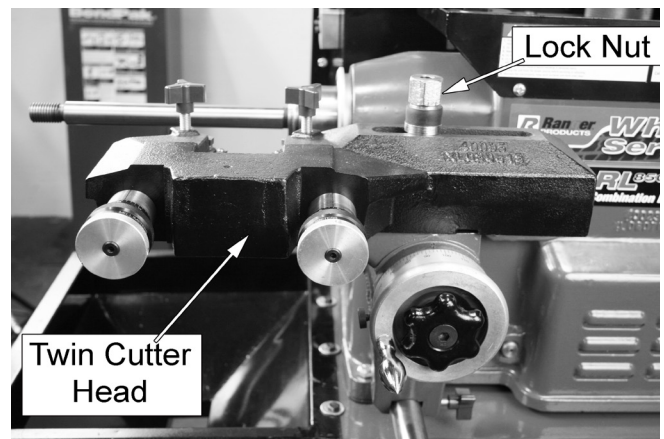
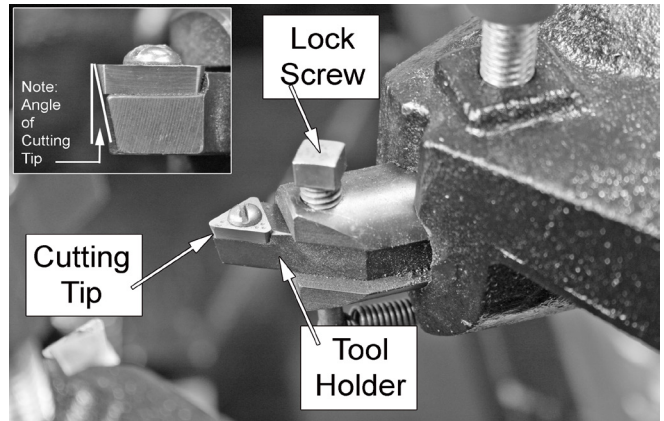

⚠ WARNING

6. The RL-8500 is shipped **WITHOUT OIL**. **BEFORE** any operation check the oil level by viewing the sight glass located on the front of the lathe. Then check that the drain plug is tight. Refer to the Maintenance section on page 40 & 41 for filling instructions.

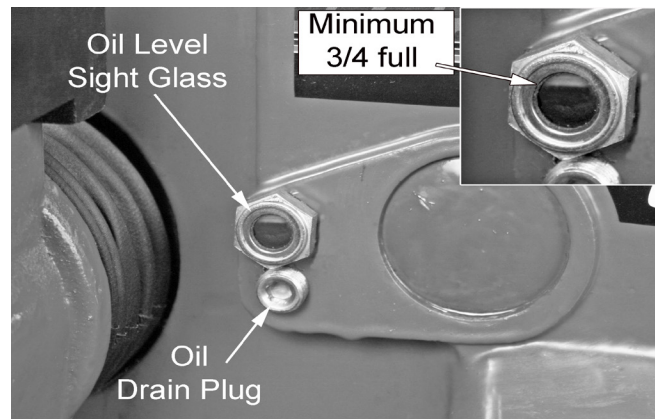

7. Check that the Main Power Switch is off.
8. Plug in the electrical power cord.

STEP 3 (Basic Operation)

To help you understand drum and rotor turning read the following that helps explain the features, operation and principles of rotor, drum and flywheel resurfacing.

Horizontal Spindle / Arbor

The spindle (horizontal main shaft) is motor driven and turns the arbor (main rod with threaded tip) upon which the brake drums or rotors are mounted. When turning the drum, rotor or flywheel via the arbor and holding a cutting tool against the braking surface, metal can be removed resulting in a smooth finish that meets original factory specifications. Smooth brake surfaces will extend the life of the brake pads and increase brake operation efficiency.

Spindle Speed

Spindle speed is adjustable by changing the position of the belt on the rear of the lathe. See page 37.

Cross Feed Assembly

The cross feed (forward and aft) draws the tool bit (micro-dial twin cutters or boring bar) across the face of a brake rotor or flywheel when the cross feed (Rotor Feed) Motor is engaged.

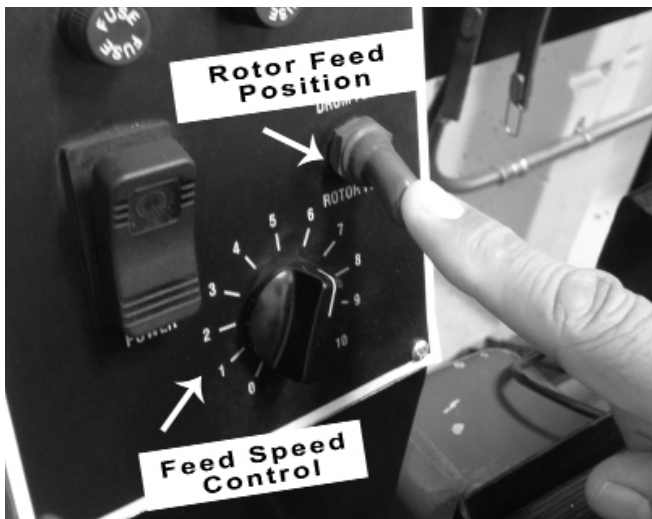

The cross feed may also be operated manually without engaging the motor using the Cross Feed Hand Wheel.

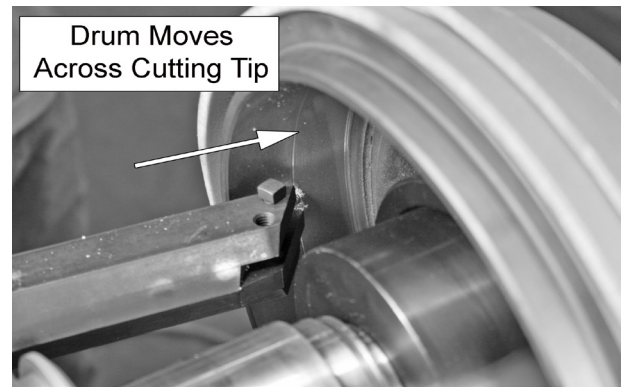

Drum Moves
Across Cutting Tip

Horizontal Spindle / Arbor Feed

By selecting the spindle feed (Drum Feed) motor, the spindle and arbor will move the mounted brake drum to the left. This feeds the drum braking surface across the cutting tool (boring bar) as the drum moves away. Spindle feed may also be done manually without engaging the spindle feed motor by using the spindle feed hand wheel. Spindle feed rate refers to the distance the spindle is moved for each revolution. This speed is variable and can be adjusted using the Feed Speed Control Dial.

The Spindle Feed may also be operated manually without engaging the motor using the Spindle Feed Hand Wheel.

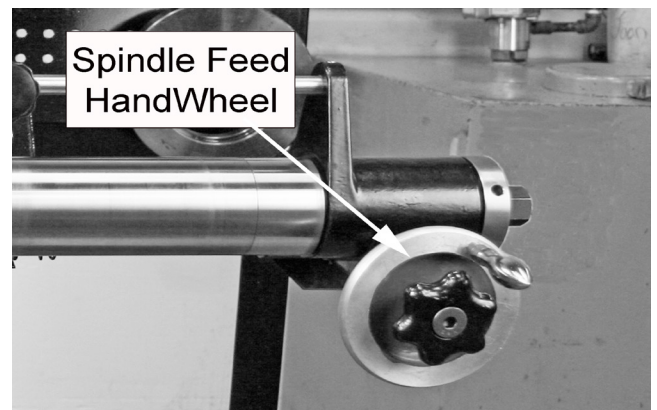
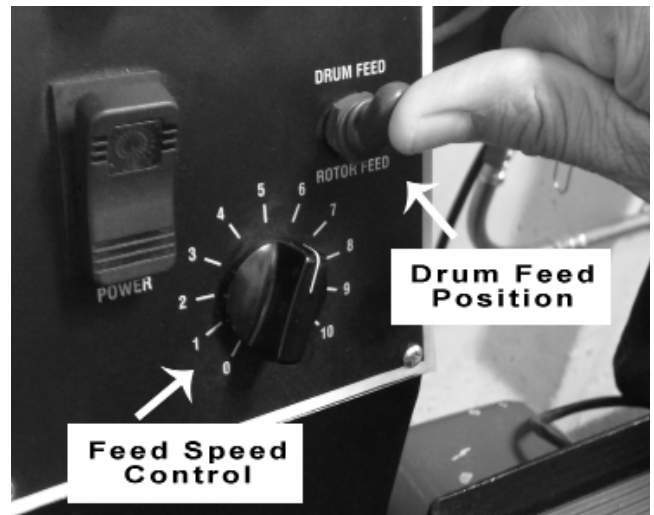

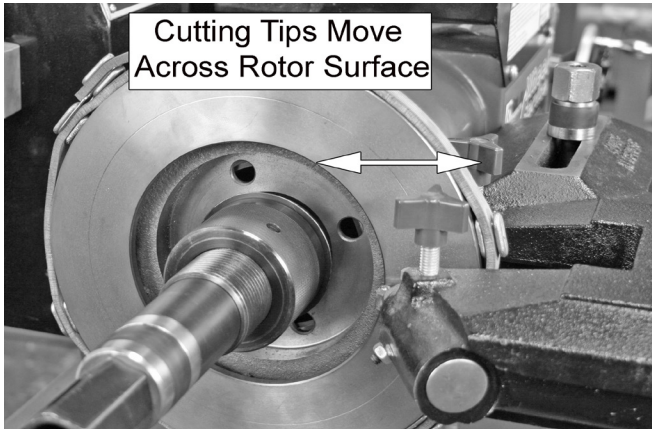

USE THESE GENERAL GUIDELINES TO DETERMINE THE DEPTH-OF-CUT

Either rough or finish cuts may be taken to resurface a rotor. Generally, finish cuts should be 0.004" (0.10 mm) to 0.004" (0.15 mm) per side. Very shallow cuts of less than 0.004" (0.10 mm) per side tend to reduce tool bit life because the heat generated during machining isn't transferred to the rotor efficiently. Rough cuts may be taken from (.006" to 0.010)

KEEP THE LATHE CLEAN OF



SHAVINGS AND CHIPS

DO NOT BLOW THE MACHINE WITH COMPRESSED AIR!

Chips and dust may be driven between machined parts and into bearings, causing undue wear. They may also contact persons in the area causing personal injury.

Use a rag or a brush to remove metal chips, shavings and dust from the lathe.

STEP 4

(Brake Rotor / Drum Inspections)

1. Before attempting any resurfacing, note that rotor and / or drum inspection is necessary. Determine the manufacturer's specifications from an approved specification guide or as cast into the rotor or drum by the manufacturer.

2. Using a digital micrometer or other measuring tool, record the thickness of the rotor or the inside diameter of the drum. Observe any deep scores and gouges. This depth will also need to be recorded. If scores or gouges are present before machining, remeasure specifications after machining is completed.



IF ANY ROTOR OR DRUM IS FOUND TO BE BEYOND SPECIFICATIONS AS CALLED FOR BY THE VEHICLE MANUFACTURER, REPLACE AS REQUIRED. NEVER ATTEMPT TO RESURFACE A ROTOR OR DRUM BEYOND LISTED SPECIFICATIONS

3. Determine if the total amount of material to be removed will meet the manufacturer's minimum specifications. If any rotor is found to be below minimum specifications as called for by the vehicle manufacture, replace as required.

WARNING

If any rotor is found to be below minimum specifications as called for by the vehicle manufacturer, replace as required. Never attempt to resurface a rotor beyond listed specifications.

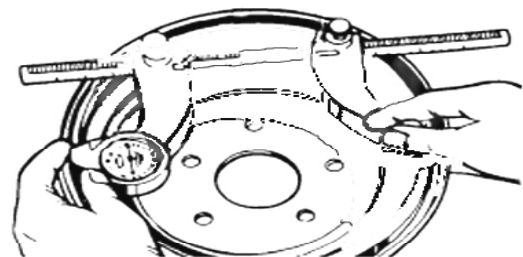
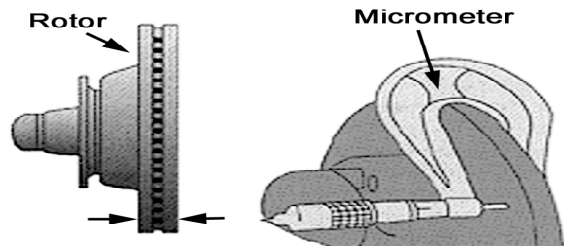

STEP 5

(Mounting the Quick Change Adapter)

Most Hubless drums and rotors can be mounted using the Quick Change Adapter. Refer to the Set up Configuration Guide on the next page for Hubbed configurations.

1. Wipe the Arbor clean of any debris.
2. Mount the Locator onto the Arbor Shaft.

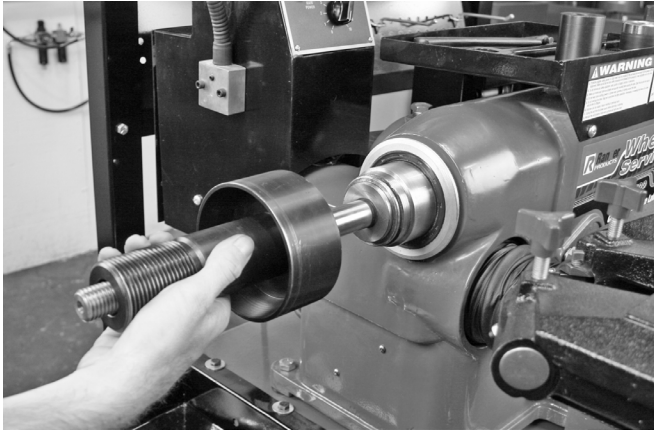

3. Mount the 2 inch Spacer

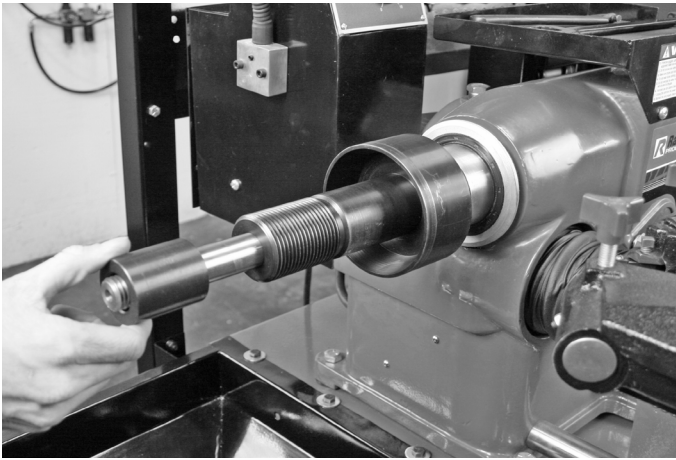

4. Mount the Self Aligning Spacer.

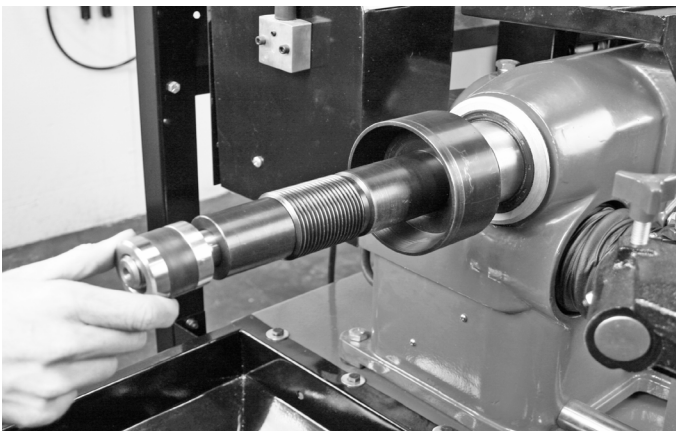

5. Mount the Arbor Nut, (reverse threaded) and hand tighten.

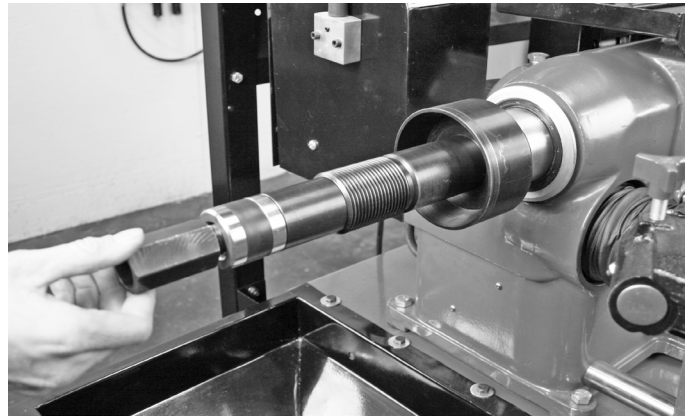

6. Tighten the Arbor Nut using the Wrench.

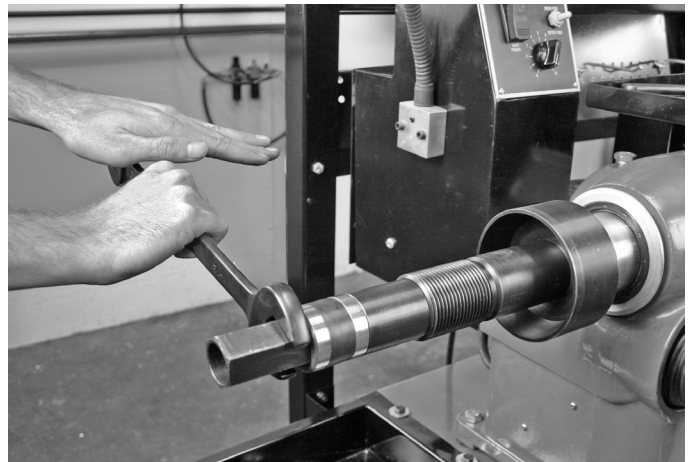

IMPORTANT NOTE !

The Self-Aligning Spacer should always be used next to the Arbor Nut when tightening. To avoid overtightening, wrench turn the Arbor Nut counterclockwise until the drum and /or adapters become fixed snug on the Arbor and so that you are unable to freely turn them. Then continue to advance the wrench 1/4 of a turn only. **DO NOT** overtighten the Arbor Nut.



Handle Adapters With Care

The adapters, arbor, and spindle are made of top grade steel, hardened, and precision ground to close tolerances. Great care should be taken in their use, handling, and storage. The smallest nick or scratch can cause incorrect drum, rotor or flywheel alignment, resulting in inaccurate resurfacing.

Set Up Configuration Guide

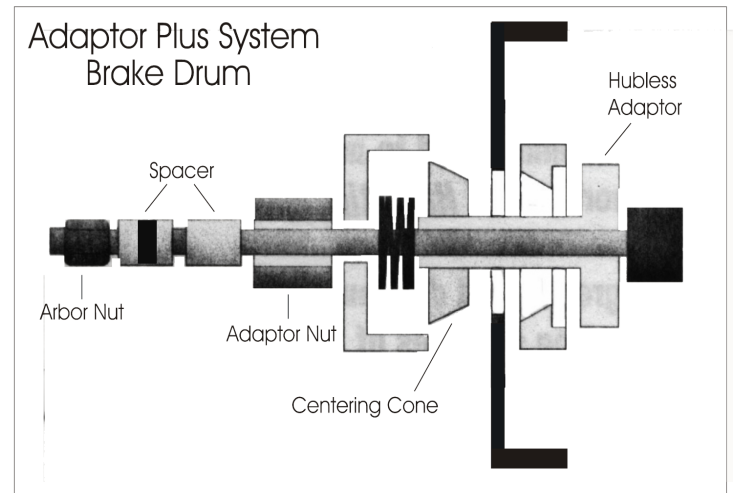
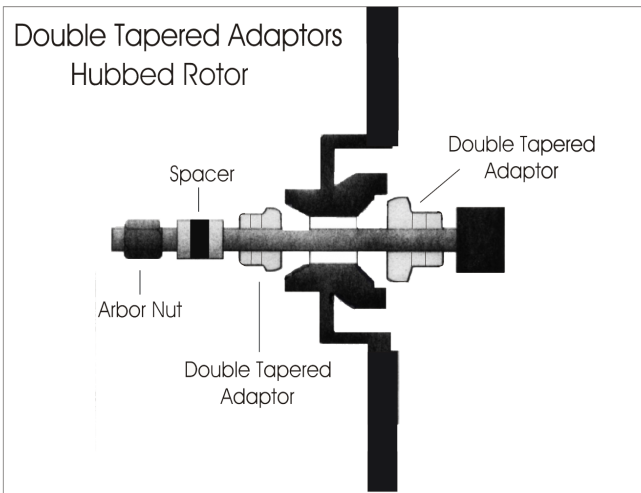
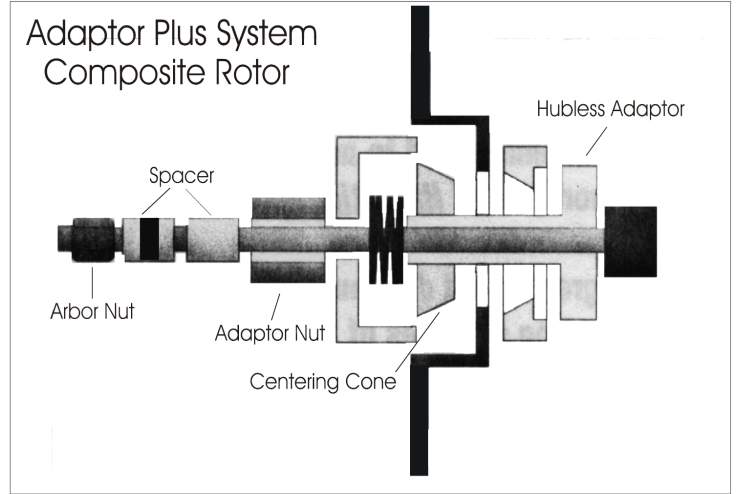
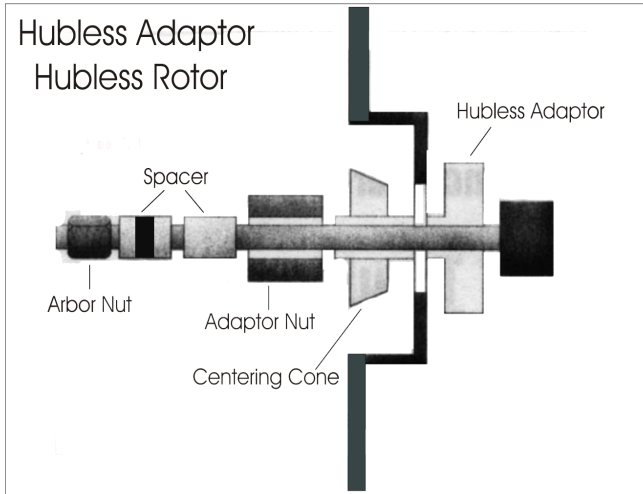

Mounting Hubbed Brake Rotors

Tapered centering cones or double taper adaptors fit in the bearing seats. Be sure to make contact near the middle of the bearing race whenever possible rather than near an edge. Various adapters and/or spacers may be used to fill out the shaft of the arbor.

Mounting Hubbed Brake Drums

Tapered centering cones or double taper adaptors fit in the drum's open center or hub. Various adapters and/or spacers may be used to locate the shaft of the arbor.

STEP 6

(Reconditioning Brake Rotors)

After the following instructions are read and understood, obtain a scrap rotor for practice. Inspect all rotors carefully for excessive scoring, rust ridges (at the inner and outer circumference of the rotor), and blemished hard spots. Any excessive wear or deformity should be noted. If the rotor is not within acceptable limits, the rotor should be replaced.

Always use a micrometer to check the thickness of the rotor. If the rotor thickness is less than the minimum established by the manufacturer, or if it will be less after reconditioning, the rotor should be replaced

WARNING

If any rotor is found to be below minimum specifications as called for by the vehicle manufacturer, replace as required. Never attempt to resurface a rotor beyond listed specifications.

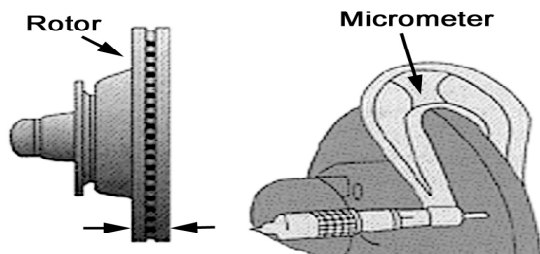

Twin Cutters

A micro-dial twin cutter tool assembly is used to recondition both surfaces of a brake rotor at the same time. The twin cutter replaces the boring bar on top of the cross feed after removing the boring bar and tool holder boring bar brackets.

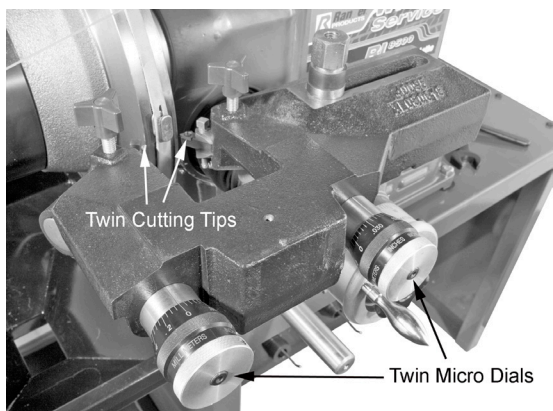

Practice setting the micro-dial cutters for machining rotors. Learn all the functions thoroughly to insure proper operation. Most rotors will have the minimum thickness values cast into the outer surface.

The proper procedure for determining whether to resurface rotors or discard them is as follows:

A. Using a micrometer or some other micrometer suitable for measuring the thickness of the rotor to be machined, check the rotor thickness at four points (90 degrees apart) about 1" from the outer diameter.

B. If the thickness at any of the four points is less than the minimum established by car manufacturers as shown on the rotor or in a current brake specifications books, replace the rotor.

C. The rotor may be resurfaced if scored or it has a small amount of runout, provided it is within the minimum thickness requirement.

D. After the rotor is machined, measure the thickness again, and, if it is not within the allowable minimum limits, discard it. NOTE: This check requires a measurement in only one spot if both braking surfaces cleaned up 100%, because the turning operation assures almost absolute parallelism.

Preparing For Twin Cutter Operations

1. If necessary, remove the boring bar and tool holder brackets and mount the Twin Cutter as described on Page 11.
2. Move the Spindle to its innermost (right hand) position by turning the Spindle Feed Hand Wheel clockwise and then back off by turning dial wheel three turns counterclockwise. On some deeper rotors it may be necessary to move the Spindle farther left. For best results, always position the Spindle as far to the right as the job will allow.

NOTE:

If the Spindle Feed Hand Wheel does not turn freely, check to make sure the Spindle Feed Hand Wheel Lock and Spindle Lock Knobs are loosened.

3. Turn the Cross Feed Hand Wheel counterclockwise and move the Cross Feed assembly away from the Arbor. This will make room for the twin cutters after the rotor is installed. If the Cross Feed Hand Wheel does not turn freely, check to make sure the Cross Feed Hand Wheel Lock and Cross Feed Lock Knob is loosened.

IMPORTANT NOTE !

If the Cross Feed Assembly moves too far outward the feed screw may exit the feed screw nut and cause the cross feed assembly to become disengaged from the hand wheel. If this happens, simply push firmly forward on the RIGHT SIDE of the Cross Feed Assembly while at the same time turning the Cross Feed Hand Wheel clockwise until the feed screw engages the feed screw nut and the Cross Feed Assembly begins to move.

Familiarize yourself with the assemblies and controls used during the Rotor Machining procedure

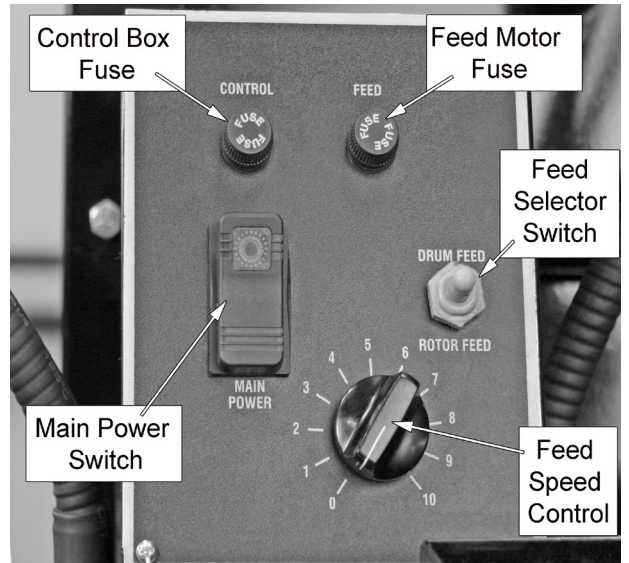
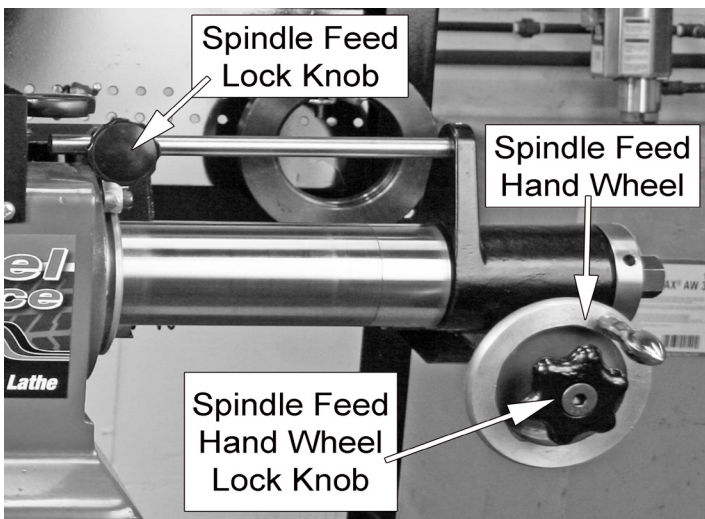
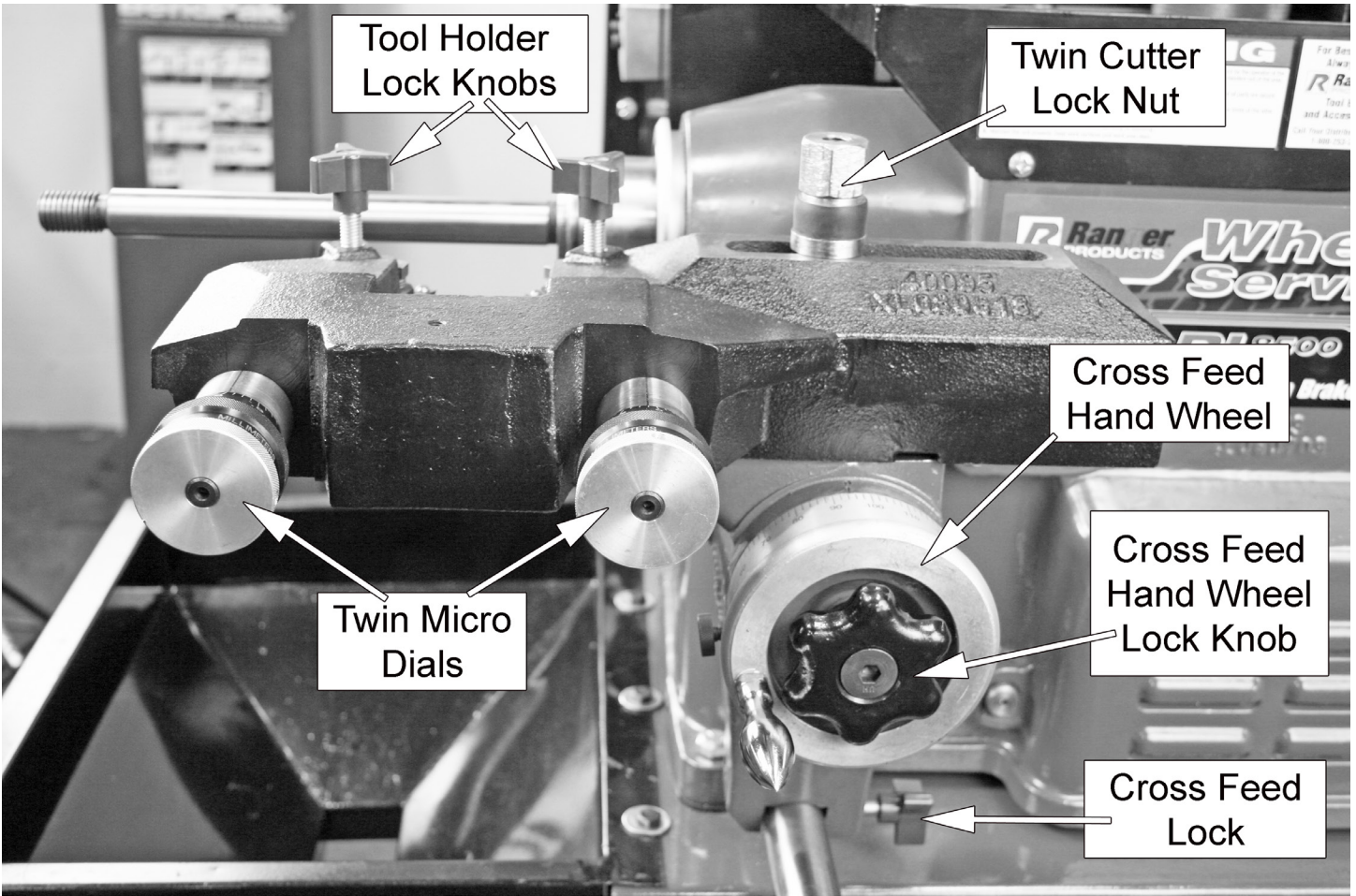

STEP 7

(Mounting The Rotor)

For most applications the Quick Change Adapter Plus should be in place for turning rotors.

Mount the Twin Cutting Head as Shown in Step 2.

1. Make sure the Twin Head Cutting Tips will clear of the edge of rotor face.
2. Loosen the Cross Feed Locking Nut.
3. Loosen the Cross Feed Handle Lock Knob.
4. Turn the Cross Feed Hand Wheel counter clock wise until the Cutting tips are clear of the edge of the rotor you will be turning.
5. Wipe any debris from the locator and arbor.
6. Ensure the Rotor is free from debris.

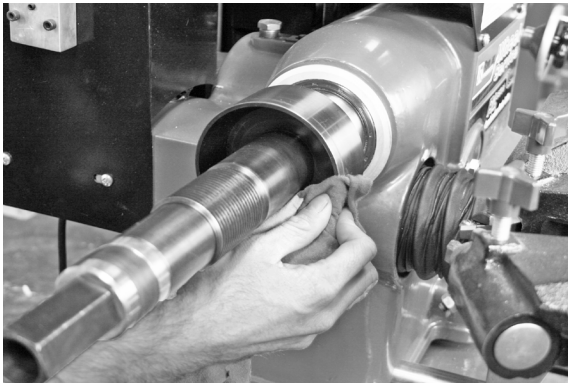

7. Mount the Rotor onto the arbor.

8. Mount the Centering Cone.



9. Hand tighten the locking nut against the Cone. (reverse threaded).



10. Firmly tighten the Locking Nut with the Spanner Wrench (reverse threaded).
11. Mount the Silencer Band and double check



making sure the Silencer Band is centered on the rotor and securely fastened.

You are now ready to check the rotor mounting and make a scratch cut.

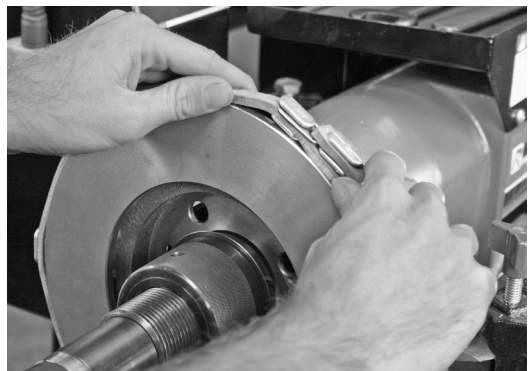

STEP 8 (Making The Scratch Cut)

1. Loosen the Cutting Tip Locking Knobs and back out both of the tips by turning the Tip Micro Dials counter clock wise, to provide clearance for the rotor.
2. Loosen the Spindle Feed Lock.
3. Loosen the Spindle Feed Hand Wheel lock.
4. Turn the Spindle Feed Wheel and center the Twin Cutter Head on the rotor.
5. Align the Twin Cutter. The slot of the twin cutter should be approximately parallel to the lathe spindle and the center of the twin cutters lined up with the center line of the rotor.

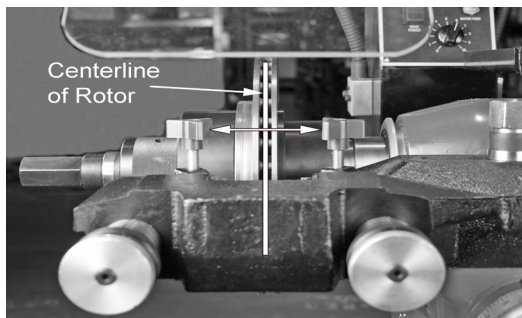

6. Secure the twin cutter to the tool holder with the self aligning Lock Nut and washer assembly. Tighten the nut firmly.
7. Tighten the Spindle locking Knob.
8. Tighten the Spindle Handle Wheel Locking Knob.
9. Install the Safety Shield. The Safety Shield is easily lowered onto the Work Light. Position the Shield / Light over the Cutting tips / rotor. Review the cautions and dangers section and the general safety information at the beginning of this manual.
10. Loosen the Cross Feed Hand Wheel Lock Knob.
11. Loosen the Cross Feed Lock Knob.
12. Turn the Cross Feed Hand Wheel clockwise until the Cutter is halfway across the face of the rotor.

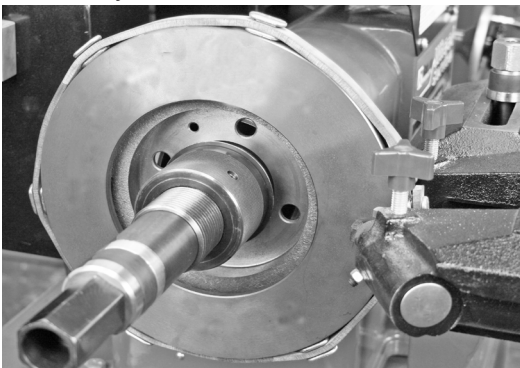

13. Check all clearances closely to make sure that nothing will “crash” when the power is turned on and the rotor starts rotating.

NOTE:

It may help to manually turn the rotor by hand to check all clearances.



ENSURE THAT THE TWIN CUTTING TIPS ARE CLEAR OF THE ROTOR PRIOR TO TURNING ON THE SPINDLE MOTOR.



MAKE SURE THE DRUM / ROTOR CROSS FEED SWITCH IS IN THE NEUTRAL POSITION.



KEEP HANDS clear of moving parts at all times. Keep hair, loose clothing, neckties, shop rags, jewelry, fingers, and all parts of body away from moving parts.



Always wear safety glasses or a face shield. Cutting an exposed surface such as a brake drum, rotor or flywheel will produce flying chips and debris.

14. Move the Feed Selector switch to the Neutral position.
15. Set the Speed Feed Dial to 0.



16. Turn the Main Power Switch on.

17. Turn each Twin Micro Dial (the outer knurled knobs) clockwise until the Cutter just barely contacts the rotor surfaces and makes a slight scratch cut.

18. Turn the Main Power Switch off.

19. Examine the scratch cut making sure it is uniform around the entire circumference of the rotor. If the scratch cut appears to be deeper on one side of the rotor and not a uniform depth, with the power off, remove the rotor from



the Arbor, check the mounting adapters and Arbor for nicks, burrs, debris or chips, remount the rotor, and repeat the process.

20. Once the rotor is determined to be mounted properly and the scratch cut is good, examine the outer edge of the rotor for any rust build up or high areas.

If there are high areas or rust build up.

Turn each Twin Micro Dials (the outer knurled knobs) clockwise until the Cutter just barely contacts the rotor surfaces and makes a slight scratch cut.

1. Zero the Cutter Hand Wheel Micrometer. Hold the outer knurled knobs firmly with your left hand, then carefully rotate the inner knurled dial indicator knobs clockwise with your right hand until ZERO is positioned at top dead center and lined up with the tick mark. This will give you an initial zero-set starting point.



2. Back off the Cutter 1-2 thousandths.

ENSURE THAT THE TWIN CUTTING TIPS ARE CLEAR OF THE ROTOR PRIOR TO TURNING ON THE SPINDLE MOTOR.



MAKE SURE THE DRUM / ROTOR CROSS FEED SWITCH IS IN THE NEUTRAL POSITION.



KEEP HANDS clear of moving parts at all times. Keep hair, loose clothing, neckties, shop rags, jewelry, fingers, and all parts of body away from moving parts.



Always wear safety glasses or a face shield. Cutting an exposed surface such as a brake drum, rotor or flywheel will produce flying chips and debris.

3. Move the Feed Selector switch to the Neutral position.

4. Set the Speed Feed Dial to 0.

5. Turn the main Power Switch on.



6. Manually turn the Cross Feed Hand Wheel counter clockwise and move the cutting tools outward toward the edge of the rotor to remove any rust build-up or high areas on the outer edge.

Repeat as necessary to remove the high spots and get the outer edge close to the over all rotor height.

7. Turn off the Main Power Switch.

After cleaning up the outer edge of the rotor manually. Proceed to Step 9 to machine the rotor.

STEP 9 (Machining The Rotor)

NOTE:

Steps 6-8 must be completed successfully before proceeding or damage to the rotor or lathe may occur.

1. Turn the outside Cutter Hand Wheel clock wise until the Cutter just touches the surface of the rotor.



2. Zero the Cutter Hand Wheel Micrometer. Hold the outer knurled knobs firmly with your left hand, then carefully rotate the inner knurled dial indicator knobs clockwise with your right hand until ZERO is positioned at top dead center and lined up with the tick mark. This will give you an initial zero-set starting point.

Note: there are both millimeter and tenths of inches graduations on the micrometer.



3. Back off the Cutter.
4. Repeat step 1-3 for the inside Cutter.
5. Turn the Cross Feed Hand Wheel clockwise until the Cutters are just past the inside edge of the face of the rotor, being careful not to run the carbide inserts into the hub portion of the rotor.



6. Adjust each Cutter Hand Wheel clockwise to remove approximately 5 - 6 thousandth of an inch of material. Remember to measure from the zero mark on the micrometer.



7. Tighten each cutter locking knob.
8. Tighten the Spindle Locking Knob.
9. Tighten the Spindle Handle Wheel Locking Knob.
10. Tighten the Cross Feed Hand Wheel Locking Knob.
11. Loosen the Cross Feed Lock Knob.
12. Tighten the Spindle Hand Wheel Locking Knob.
13. Check all clearances closely to make sure that nothing will "crash" when the power is turned on and the rotor starts rotating.

NOTE:

It may help to manually turn the rotor by hand to check all clearances.
ENSURE THAT THE TWIN CUTTING TIPS ARE



CLEAR OF THE ROTOR PRIOR TO TURNING ON THE SPINDLE MOTOR.

! WARNING

MAKE SURE THE DRUM / ROTOR CROSS FEED SWITCH IS IN THE NEUTRAL POSITION.

! CAUTION

KEEP HANDS clear of moving parts at all times. Keep hair, loose clothing, neckties, shop rags, jewelry, fingers, and all parts of body away from moving parts. Always wear safety glasses or a face shield. Cutting

! CAUTION

an exposed surface such as a brake drum, rotor or flywheel will produce flying chips and debris.

14. Turn the main Power Switch on.
15. Move the Feed Selector switch to the Rotor position.
16. Set the Speed Feed Dial to 4- 6.

17. The Cross feed is feeding properly when the Cross Feed Handle Wheel is not turning.

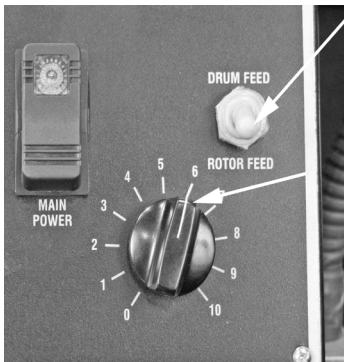

When the Cutter is finished.



18. Set the Speed Feed Dial to 0.



19. Move the Feed Selector Switch to Neutral.
20. Turn off the Main Power Switch.
21. Loosen the Cross Feed Hand Wheel lock.
22. Back off the Twin Cutter head Assemble by turning the Cross Feed Hand Wheel counter clock wise.
23. Check the machined surface.



If your cutting bits are in good condition and the feed rate was set at six or below. The finish should be excellent.

If necessary, perform another pass until the finish is acceptable.

When the machining is complete.

1. Remove the Silencer Band.
2. Loosen the Locking Nut using the spanner wrench.
3. Remove the Locking Nut.
4. Remove the Centering Cone.
5. Remove the Rotor.

If you are turning more hubless rotors or drums you can leave the Quick Change Adapter on the machine.

STEP 10 (Mounting A Composite Rotor)

For most applications the Quick Change Adapter Plus should be in place for turning rotors. Please follow these directions:

1. Make sure the Twin Head Cutting Tips will clear of the edge of rotor face.



2. Loosen the Cross Feed Locking Nut.



3. Loosen the Cross Feed Hand Wheel Lock Knob.



4. Turn the Cross Feed Hand Wheel counter clock wise until the Cutting Tips are clear of the edge of the rotor you will be turning.



5. Wipe any debris from the locator and arbor.



6. Ensure the Rotor is free from debris.

7. Mount the proper size Backing Plate onto the locator.

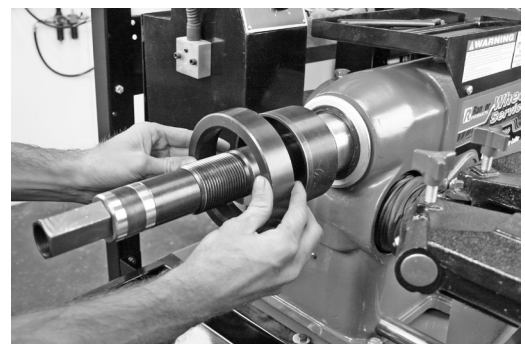

8. Mount the rotor.



11. Hand tighten the Locking Nut against the Cup (reverse threaded).



9. Mount the Centering Cone.

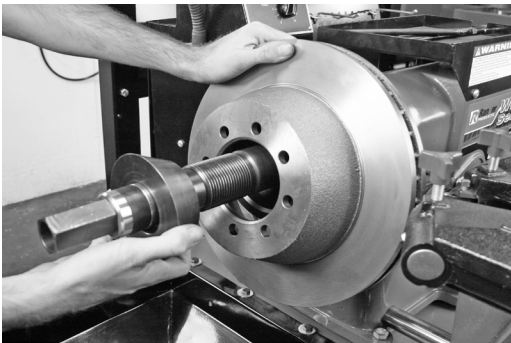

12. Firmly tighten the Locking Nut with the Spanner Wrench (reverse threaded).

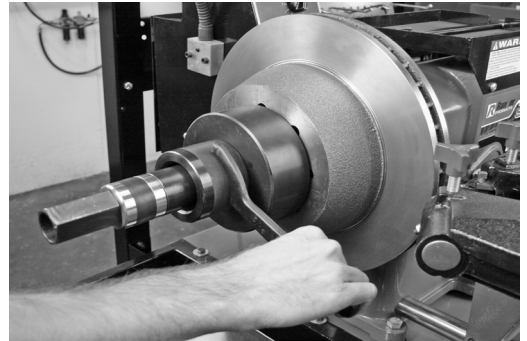

10. Mount the appropriate size Cup with the built in spring.

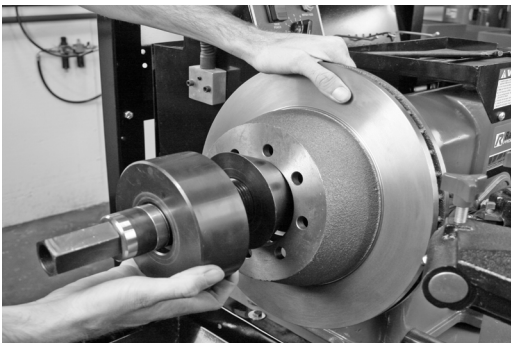

13. Mount the Silencer Band and double check making sure the band is centered on the rotor and securely fastened.

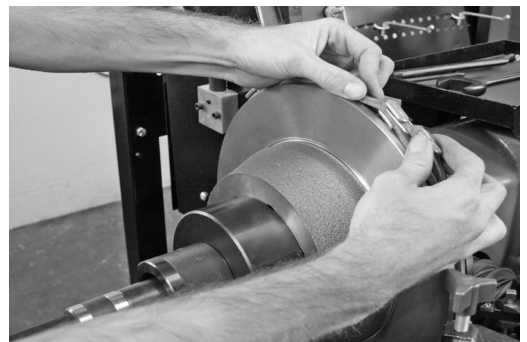

Once the rotor is successfully mounted refer back to Steps 8 and 9 to complete the machining of the rotor.

DRUM AND FLYWHEEL SET UP

Familiarize yourself with the assemblies and controls used during the Drum and Flywheel Machining procedure.

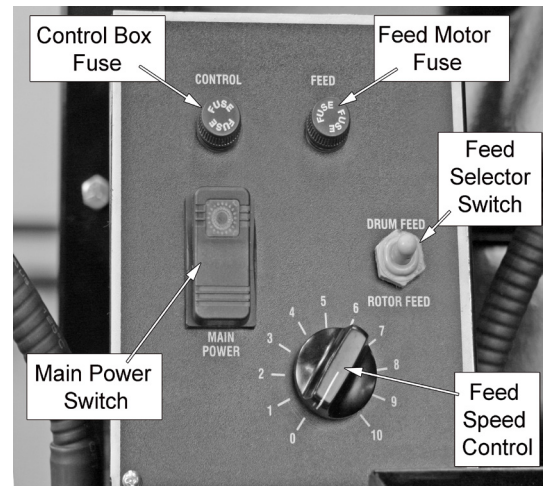
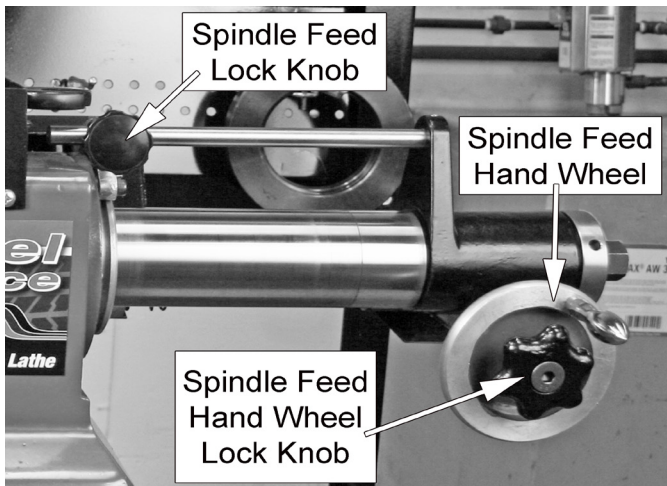
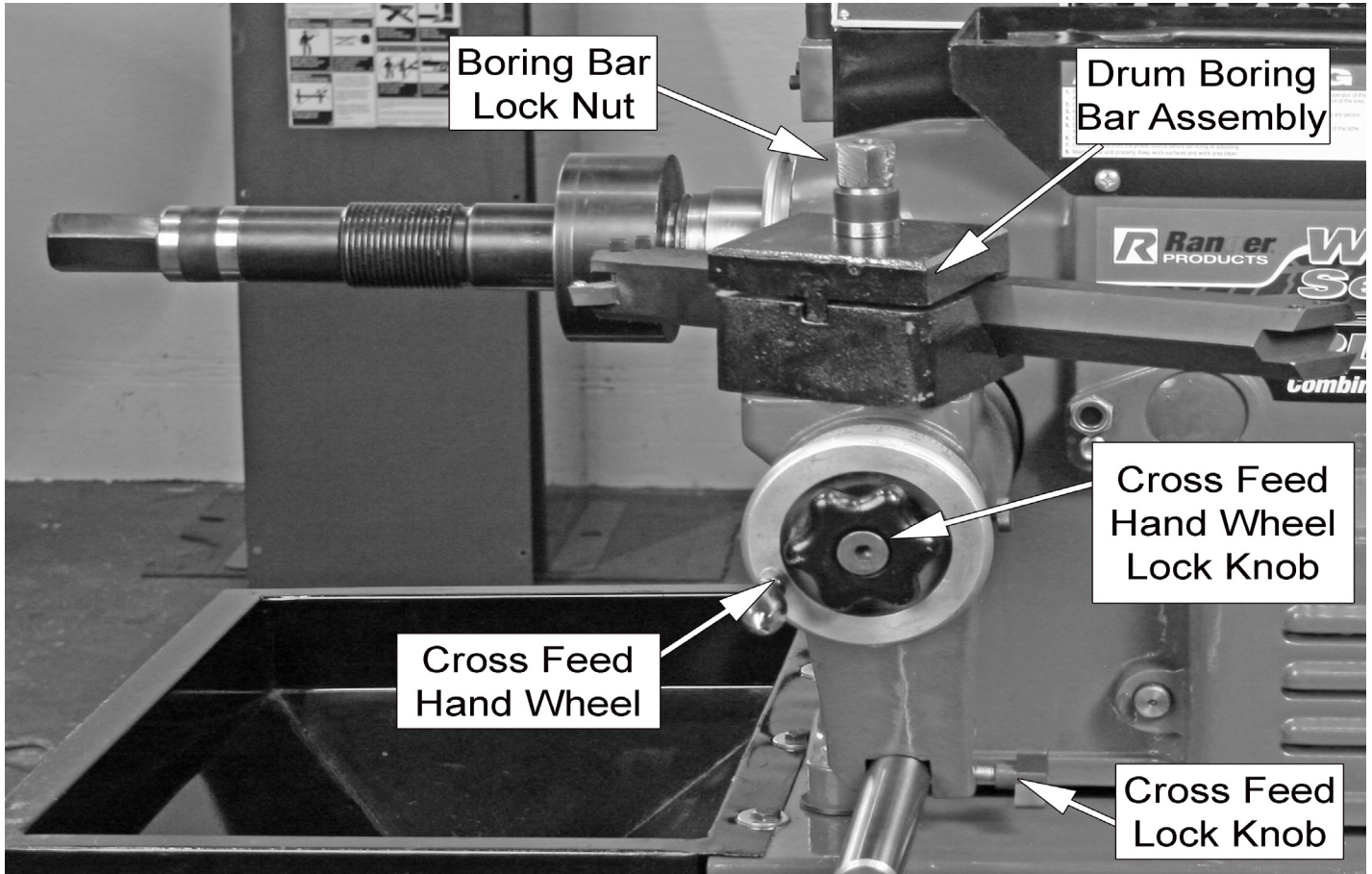

STEP 11 (Boring Bar Set Up) (for Machining Drum)

If necessary, remove the Twin Cutter Assembly.

1. Clean the Cross Feed mounting Surface.



2. Loosely mount the Drum Tool Bar Assembly.



3. Be sure that a proper tool bit is secure in the Boring bar and the cutting tip is not excessively worn. Sharp cutting tips must be used at all times. A dull cutter will affect the finish of both drums and rotors. If the cutting edge is damaged, replace it promptly. Be sure no metal chips are under tip when changing tips.

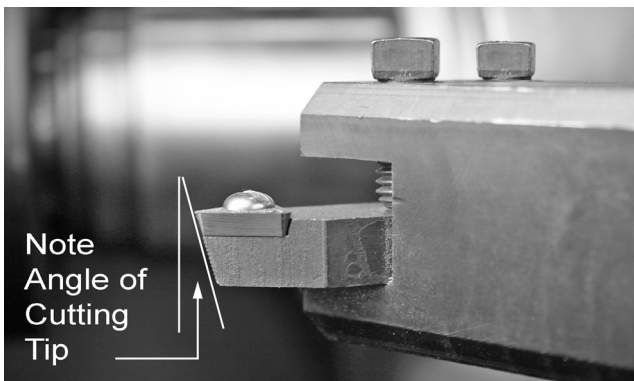

STEP 12 (Drum Mounting)

1. Clean the surface of the Hubless adapter.



2. Mount the proper size backing plate onto the Hubless Adapter.



3. Remove any debris from the drum.
4. Mount the drum onto the arbor.

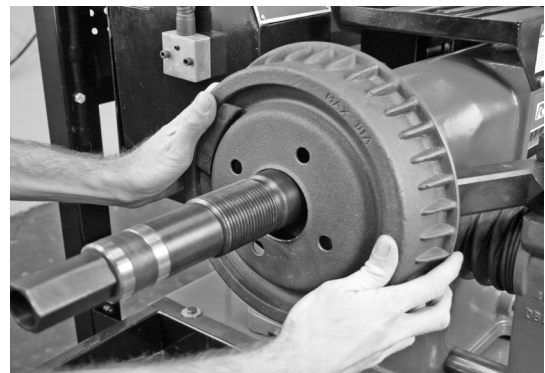

5. Mount the Centering Cone.



8. Firmly tighten the Locking Nut with the Spanner wrench (reverse threaded).



6. Mount the appropriate sized Cup with the Built in spring.



9. Mount the Silencer Band and double check the Silencer Band is centered on the drum and securely fastened.



7. Hand tighten the Locking Nut against the Cup. (reverse threaded).



Always wear safety glasses or a face shield.
Cutting an exposed surface such as a brake drum, rotor
or flywheel will produce flying chips and debris.

STEP 13

(Making the Drum Scratch Cut)

1. Using the Spindle Feed Hand Wheel, move the spindle to its innermost (right hand) position by turning the hand wheel clockwise and then back off by turning dial wheel two turns counterclockwise.

NOTE:

If the hand wheel does not turn freely, check to make sure the Spindle Lock and Spindle Feed Hand Wheel Lock knobs are loosened.

2. Next, position the Boring Bar by loosening the Tool Holder Lock Nut and sliding the Boring Bar Assembly so that the Cutting tip is positioned just along the inside edge of the drum. Adjust the Cross Feed Hand Wheel as necessary until the boring bar is as close to parallel to the inside of the drum surface. The cutting tip should be as close to 90° to the inside drum surface as possible.

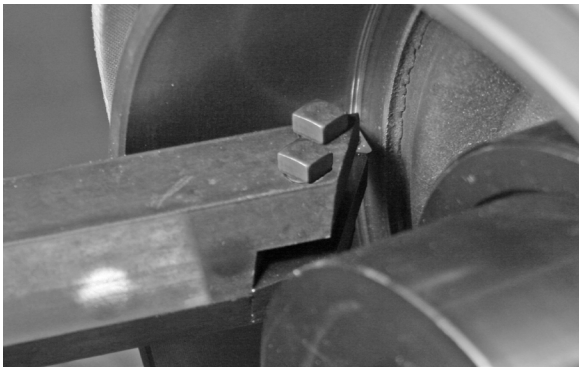

3. Secure the Boring Bar Assembly with the self-aligning nut and washer assembly. Tighten the nut firmly.



4. Rotate the Spindle Feed hand Wheel counter clockwise until the Cutter is halfway across the inner face of the drum

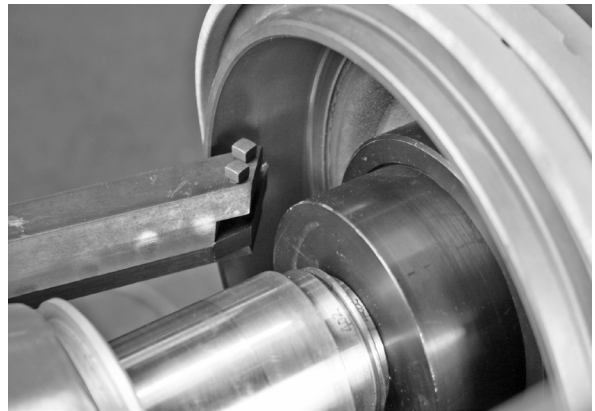

5. Tighten the Spindle Locking Knob.
6. Tighten the Spindle Feed Hand Wheel Locking Knob.
7. Install the Safety Shield. The safety shield is easily lowered onto the work light. Position the Shield / Light over the Cutting tips rotor. Review the cautions and dangers section and the general safety information at the beginning of this manual.
8. Loosen the Cross Feed Hand Wheel Lock Knob.
9. Loosen the Cross Feed Lock Knob.
10. Rotate the Cross Feed Hand Wheel Counter clockwise so that the cutter just touches the surface of the drum.
11. Zero the Cross Feed hand Wheel Micrometer and lock it in place.

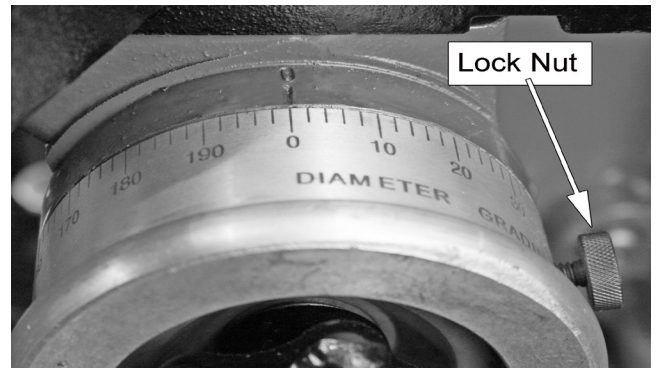

12. Back off the Cutting Tip by turning the Cross Feed Hand Wheel Counter clockwise.
13. Check all clearances closely to make sure that nothing will "crash" when the power is turned on and the rotor starts rotating.

NOTE:

It may help to manually turn the Drum by hand to check all clearances.



ENSURE THAT THE CUTTING TIP IS CLEAR OF THE DRUM PRIOR TO TURNING ON THE SPINDLE MOTOR.



MAKE SURE THE DRUM / ROTOR CROSS FEED SWITCH IS IN THE NEUTRAL POSITION.



KEEP HANDS clear of moving parts at all times. Keep hair, loose clothing, neckties, shop rags, jewelry, fingers, and all parts of body away from moving parts.



Always wear safety glasses or a face shield. Cutting an exposed surface such as a brake drum, rotor or flywheel will produce flying chips and debris.

14. Move the Feed Selector Switch to the Neutral position.

15. Set the Speed Feed Dial to 0.



16. Turn on the Main Power Switch.

17. Rotate the Cross Feed Hand Wheel counter clock wise until the Cutter begins to cut a shallow scratch cut in the drum.

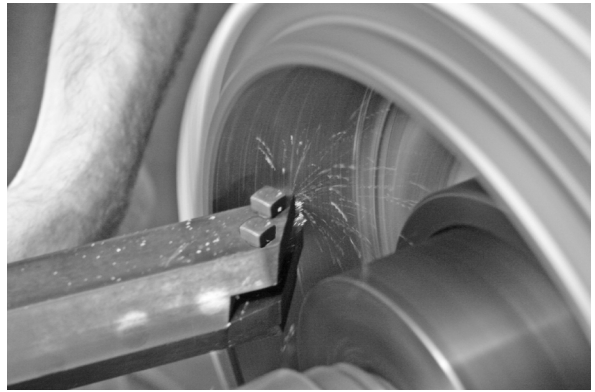

18. Back of the Cutter by turning the Cross Feed Hand Wheel Clock wise.

19. Turn off the Main Spindle Power.

20. Examine the scratch cut making sure it is uniform around the entire circumference of the drum. If the scratch cut appears to be deeper on one side of the drum and not a uniform depth, remove the drum from the arbor, check the mounting adapters and arbor for nicks, burrs, or chips, remount the drum, and repeat the process.



Once the drum is determined to be mounted properly and the scratch cut is good, continue on to Machining the Drum in Step 14.

STEP 14 (Machining the Drum)

NOTE:

Complete Steps 6-8 successfully before proceeding or damage to the Drum or lathe may occur.

NOTE;

Verify the Cross feed Micrometer is still Zeroed out by rotating the Cross Feed Hand Wheel Counter clockwise until the tip just touches the drum surface. Adjust the Micrometer as needed and lock the micrometer at the Zero mark.

1. Back off the tip by turning the Cross Feed Hand Wheel clockwise.
2. Loosen the Spindle Locking Knob.
3. Loosen the Spindle Hand Wheel Locking Knob.
4. Rotate the Spindle Feed Hand Wheel clockwise until the cutter just clears the inside edge of the drum.

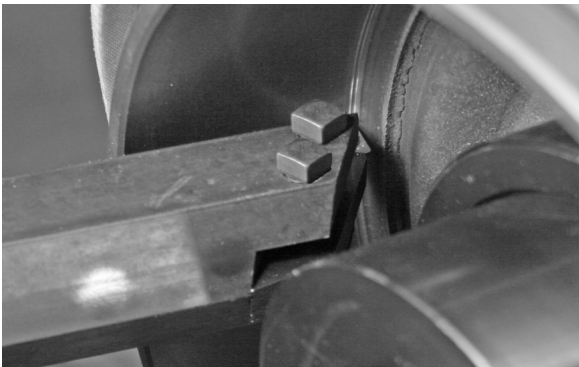

5. Tighten the Spindle Handle Wheel Locking Knob.
6. Loosen the Spindle Feed Lock.
7. Make sure the Cutter and the Tool Bar are clear of the drum and the backing plate.
8. Check all clearances closely to make sure that nothing will "crash" when the power is turned on and the drum starts rotating.

NOTE:

It may help to manually turn the Drum by hand to check all clearances.



ENSURE THAT THE CUTTING TIP IS CLEAR OF THE DRUM PRIOR TO TURNING ON THE SPINDLE MOTOR.



MAKE SURE THE DRUM / ROTOR CROSS FEED SWITCH IS IN THE NEUTRAL POSITION.



KEEP HANDS clear of moving parts at all times. Keep hair, loose clothing, neckties, shop rags, jewelry, fingers, and all parts of body away from moving parts.



Always wear safety glasses or a face shield. Cutting an exposed surface such as a brake drum, rotor or flywheel will produce flying chips and debris.

9. Turn on the Main Power Switch.

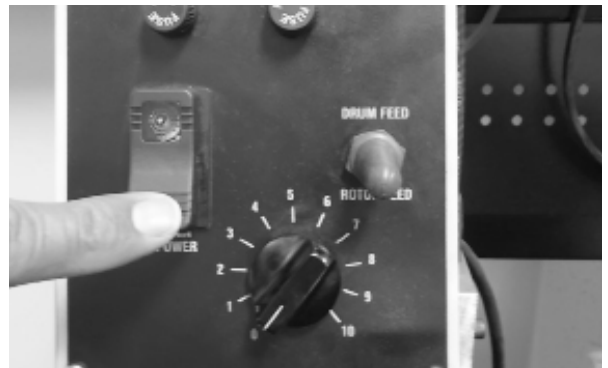

10. Adjust Cross Feed Hand Wheel counter -clockwise to remove approximately 5 - 6 thousandth of an inch of material. Remember to measure from the zero mark on the micrometer.
11. Lock the Cross Feed Hand Wheel.
12. Lock the Cross Feed.
13. Move the Feed Selector switch to the Drum position.

14. Set the Speed Feed Dial to 4- 6.

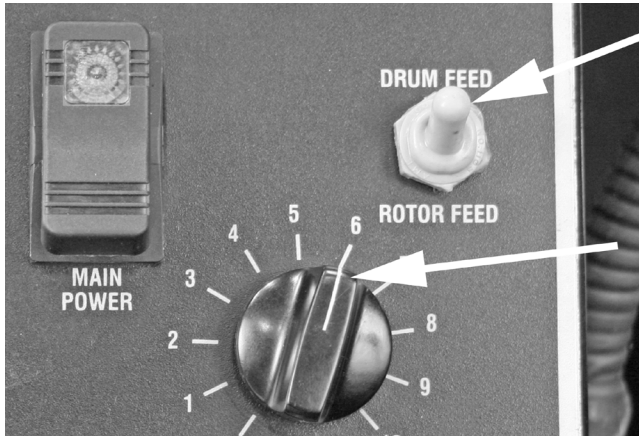

15. Move the Feed Selector switch to neutral when the machining is finished.

16. Turn off the Main Power Switch.

17. Set the Speed Feed dial to 0.



18. Loosen the Spindle Feed Handle Wheel lock.



19. Back off the Cutter Bar Assembly by turning the Spindle Feed Hand wheel counter clock wise.

Check the machined Surface.



If your cutting bits are in good condition and the feed rate was set at six of below, the finish should be excellent.

If necessary, perform another pass until the finish is acceptable.

When the machining is complete.

1. Remove the Silencer Band.
2. Loosen the Locking Nut using the spanner wrench.
3. Remove the Locking Nut.
4. Remove the Cup with the built in Spring.
5. Remove the Centering Cone.
6. Remove the Drum.

If you are turning more hubless rotors or drums you can leave the Quick Change Adapter on the machine.

STEP 15

(Boring Bar Set Up) (for Flywheel Machining)

1. If necessary, remove the Rotor Cutter Assembly.
2. Rotate the Cross Feed Hand Wheel clockwise until the Cross Feed is almost all the way in. Then Turn the Cross Feed hand Wheel counter clockwise two turns.
3. Clean the mounting Surface.
4. Loosely mount the Drum Tool Bar Assembly.

NOTE:

You may have to reverse the Tool bar Clamp Assembly to get the Cutter in the proper position. The Cutter should be as close to 90° to the face of the flywheel as possible.



NOTE:

Some Flywheels can use the Quick Adapter System for mounting of the flywheel. Mount as you would a rotor using the appropriate cups and or backing plate as needed.

For illustration purposes the flywheel will be mounted without using the Quick Change Adapter System.

Remove the Quick Change Adapter System by reversing the steps shown in Step 5.

NOTE:

Some smaller flywheels can be turned using the inner Cutter on the Twin Cutter. Follow the procedures as outlined in the Rotor Section, using only the inner Cutting Tip.

STEP 16

(Mounting Flywheels)

1. Clean the Arbor make sure it is free of all debris.
2. Slide the Bell Clamp onto the Arbor.

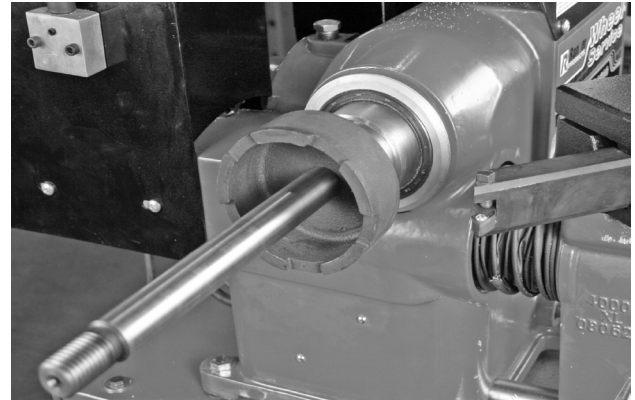

3. Ensure all pins and bolts are removed from the flywheel prior to mounting.
4. Remove any debris from the Flywheel.
5. Mount the Flywheel onto the Arbor.
6. Mount the Centering Cone.



7. Use spacers as needed to fill up the space on the Arbor so the Arbor Nut will tighten the flywheel against the Cup.



8. Hand tighten the Arbor Nut. (reverse threaded).

IMPORTANT NOTE !



The self-aligning spacer should always be used next to the arbor nut when tightening. To avoid overtightening, wrench turn the arbor nut counterclockwise until the rotor, drum, flywheel, and /or adapters become fixed snug on the arbor and so that you are unable to freely turn them. Then continue to advance the wrench 1/4 of a turn only.

DO NOT overtighten the arbor nut.

9. Firmly tighten the Arbor Nut with the Wrench (reverse threaded).

IMPORTANT NOTE

Dowel pins or studs must be removed before machining can be performed. Use silencers when possible. Magnet packs or bars may be used as silencers.



STEP 17

(Scratch Cut on the Flywheel)

1. Loosen the Tool Bar Lock Nut and position the tool bar so that the cutter is just inside the inner edge of the flywheel surface. The Cutter should be as close to 90° to the face of the flywheel as possible. Using the Cross Feed Hand Wheel, move the Cross Feed to its innermost position by turning the Hand Wheel clockwise and then back off by turning the Cross Feed Hand Wheel counter clockwise two turns.

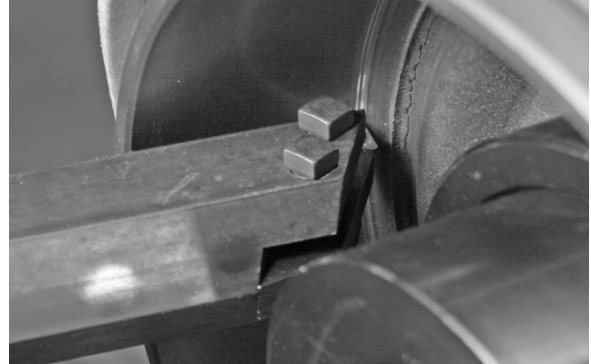

2. Tighten the Tool Bar Lock Nut with the Wrench.
3. Rotate the Cross Feed Hand Wheel counter clockwise so that the cutting tip is positioned half way across the flywheel surface.
4. Loosen the Spindle Locking Knob.
5. Loosen the Spindle Handle Wheel Locking Knob.
6. Rotate the Spindle Feed Hand Wheel clockwise until the Cutter just touches the Flywheel Surface.



7. Back of the Cutter by rotating the Spindle Feed Hand Wheel clockwise until the cutter just clears the flywheel surface.
8. Check all clearances closely to make sure that nothing will "crash" when the power is turned on and the flywheel starts rotating.

NOTE:

It may help to manually turn the Flywheel by hand to check all clearances.

CAUTION

ENSURE THAT THE CUTTING TIP IS CLEAR OF THE FLYWHEEL PRIOR TO TURNING ON THE SPINDLE MOTOR.

MAKE SURE THE DRUM / ROTOR CROSS FEED

WARNING

SWITCH IS IN THE NEUTRAL POSITION.
KEEP HANDS clear of moving parts at all times. Keep

CAUTION

hair, loose clothing, neckties, shop rags, jewelry, fingers, and all parts of body away from moving parts. Always wear safety glasses or a face shield. Cutting an exposed surface such as a brake drum, rotor or flywheel will produce flying chips and debris.

9.. Move the Feed Selector Switch to the Neutral position.

10. Set the speed feed dial to 0.

11. Turn on the Main Spindle Power Switch.



12. Rotate the Spindle Feed Hand Wheel clock wise until the Cutter begins to cut a shallow scratch cut in the flywheel.

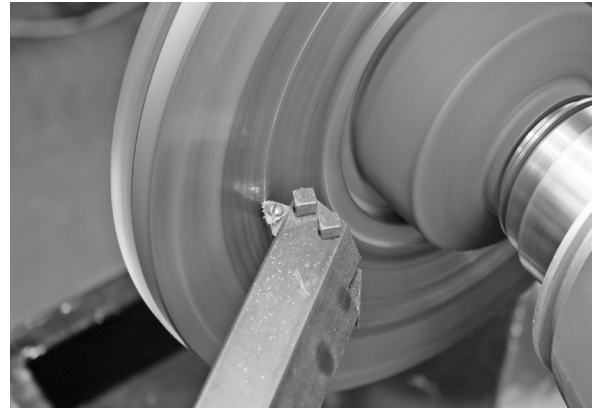

13. Back off the Cutter by turning the Spindle Feed Hand Wheel Clock wise.

14. Turn off the Main Spindle Power.

15. Examine the scratch cut making sure it is uniform around the entire circumference of the flywheel. If the scratch cut appears to be deeper on one side of the flywheel and not a uniform depth, remove the flywheel from the arbor, check the mounting adapters and arbor for nicks, burrs, or chips, remount the flywheel, and repeat the process.



Once the flywheel is determined to be mounted properly and the scratch cut is good, continue on the machining the Flywheel in Step 18.

STEP 18

(Machining the Flywheel)

NOTE:

Complete Steps 15-17 successfully before proceeding or damage to the Flywheel or lathe may occur.

1. Rotate the Cross Feed Hand Wheel counter clock wise so that the cutting tip is positioned just inside the inner edge flywheel surface.

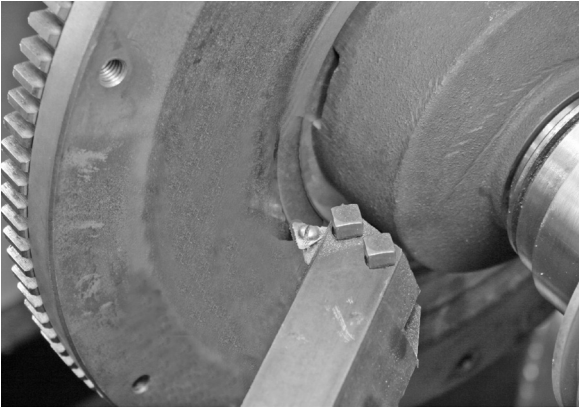

2. Loosen the Spindle Feed Locking Knob.
3. Loosen the Spindle Handle Wheel Locking Knob.
4. Rotate the Spindle Feed Hand Wheel clock wise until the Cutter just touches the Flywheel Surface.
5. Rotate the Spindle Feed Hand Wheel counter clockwise until the Cutter just clears the flywheel surface.
6. Lock the Cross Feed Hand Wheel.
7. Loosen the Cross Feed Lock Knob.
8. Check all clearances closely to make sure that nothing will "crash" when the power is turned on and the flywheel starts rotating.

NOTE:

It may help to manually turn the Flywheel by hand to check all clearances.



ENSURE THAT THE CUTTING TIP IS CLEAR OF THE FLYWHEEL PRIOR TO TURNING ON THE SPINDLE MOTOR.



MAKE SURE THE DRUM / ROTOR CROSS FEED SWITCH IS IN THE NEUTRAL POSITION.



KEEP HANDS clear of moving parts at all times. Keep hair, loose clothing, neckties, shop rags, jewelry, fingers, and all parts of body away from moving parts.



Always wear safety glasses or a face shield. Cutting an exposed surface such as a brake drum, rotor or flywheel will produce flying chips and debris.

9. Turn on the Main Power Switch.
10. Move the Feed Selector switch to the Rotor position.
11. Set the Speed Feed Dial to 4-6.

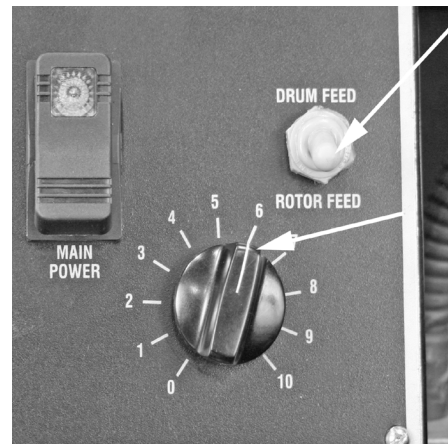

12. Rotate the Spindle Feed Hand Wheel counter -clock-wise to remove approximately 5 - 6 thousandth of an inch of material.
13. Lock the Spindle Feed Hand Wheel.
14. Lock the Spindle Feed Lock Nut.

NOTE:

When machining cup-type flywheels you must stay with the lathe, because you must stop the unit and reposition the tool bar for the outside lip surface. You must also remove the same amount from the outside mounting surface as was removed from the lower surface; failure to do this may cause incorrect clutch operation.

15. Move the Feed Selector switch to neutral when the machining is finished.

16. Set the Speed Feed dial to 0.

17. Turn off the Main Power Switch.



When the machining is complete;

1. Loosen the Spindle Feed Hand Wheel Lock and the Spindle Feed Lock Knob back the Tool bar out of the way.

2. Loosen the Locking nut using the Spanner wrench.



18. Loosen the Spindle feed Hand Wheel lock.



19. Back off the Cutter Bar Assemble by turning the Spindle Feed Hand wheel counter clockwise.

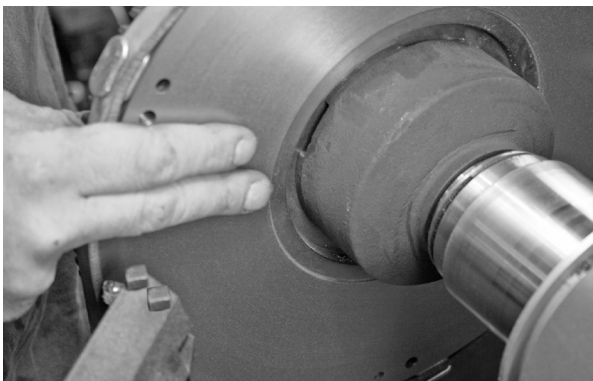

Check the machined Surface.

If your cutting bits are in good condition and the feed rate was set at six of below, the finish should be excellent.

3. Remove the Locking Nut

4. Remove the Centering Cone

5. Remove the Flywheel.



KEEP HANDS clear of moving parts at all times.



STEP 19

(Spindle Speed Adjustment)

NOTE:

Ensure that the lathe is free of chips and any metal shavings before opening the Main Motor Cover

1. Disconnect lathe from the Power Source.
2. Open the Main Motor Cover.
3. Loosen the Motor Mount Bolt.

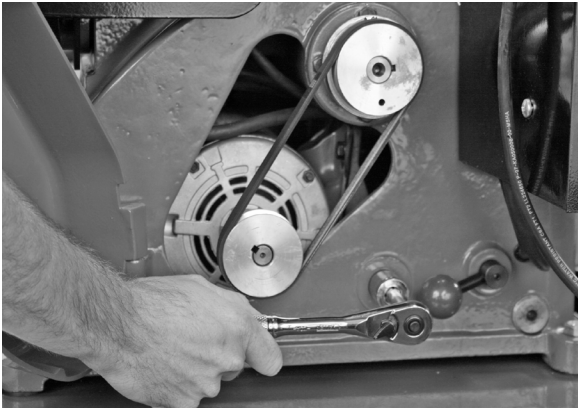

4. Raise the Belt Tensioner Handle Up to loosen the belt tension. Flip the Belt Tensioner Handle Up to loosen the belt tension.

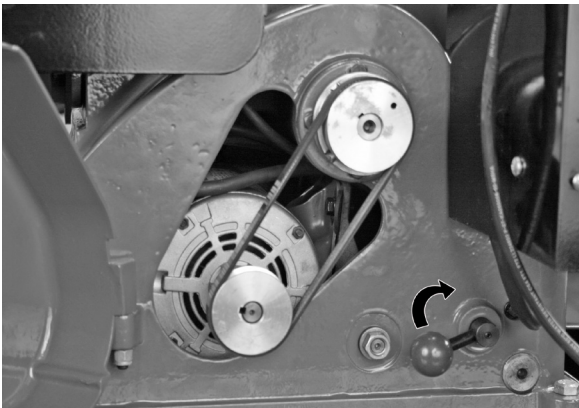

5. Lift up on the motor then move Belt to the desired Pulley set.

Inner Pulley Set

150 RPM

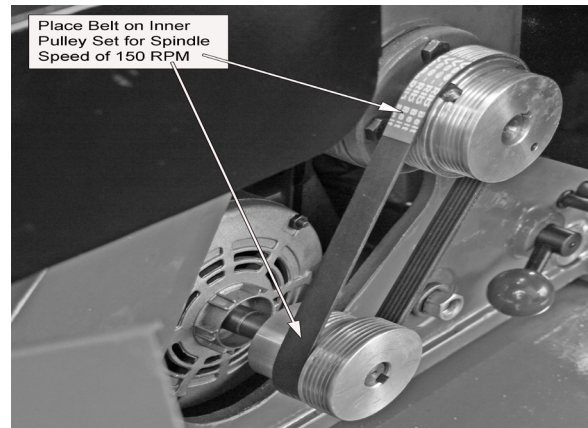

Outer Pulley Set

200 RPM

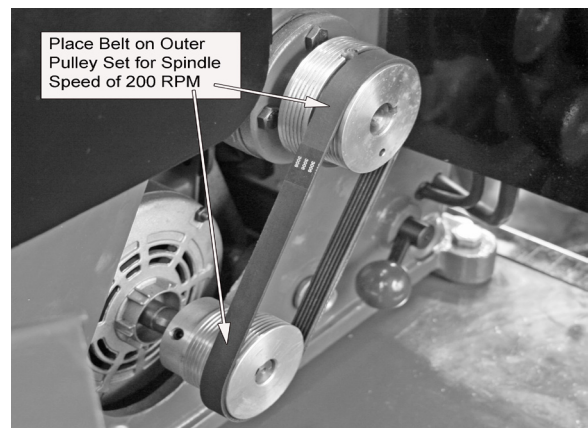

6. Lower Belt Tensioner Down.
7. Tighten Motor Mount Bolt.
8. Close the Cover.

STEP 20

(Feed Motors Belt Replacement)

Cross Feed Motor Belt Replacement.

NOTE:

Ensure that the lathe is free of chips and any metal shavings before opening the Cross Feed Motor Cover.

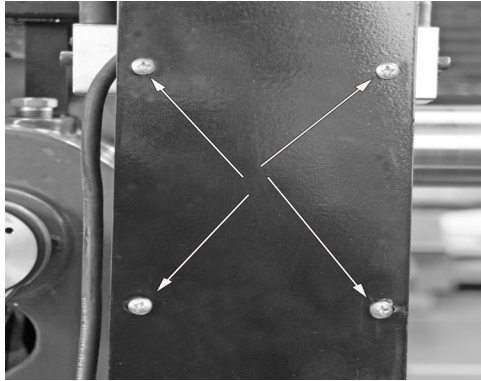

1. Remove the four Screws from the Cross Feed Motor Cover.
2. Loosen the four Socket Head Caps screws and slide the motor down until there is enough slack to remove the Belt.

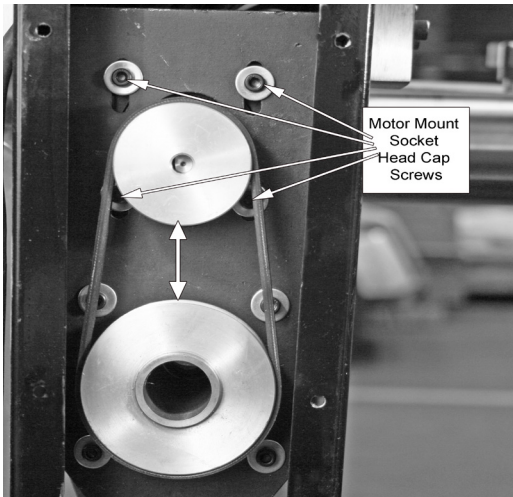

3. Remove old Belt.
4. Place new Belt on pulleys.
5. Pull Motor up, adjust so that there is approximately 1/4" deflection, and tighten the four Socket Head Cap Screws.
6. Replace the Cross Feed Motor Cover.

Spindle Feed Motor Belt Replacement

NOTE:

Ensure that the lathe is free of chips and any metal shavings before performing the Belt Replacement Procedure.



1. Remove the two Screws from the Spindle Feed Motor Cover.
2. Loosen the four Socket Head Caps Screws and slide the motor left until there is enough slack to remove the Belt. You may need to remove the lower left Screw to gain enough clearance to remove the belt.
3. Remove the two Screws from the Spindle Feed Gear Cover. Keep track of the two Spacers beneath the Gear Cover.

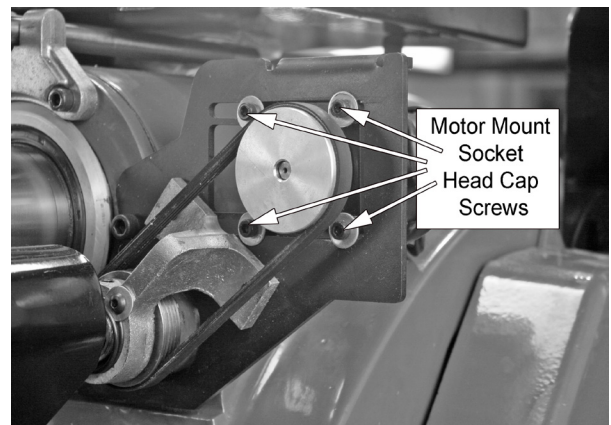

4. Remove the Drum Feed Screw Nylock Nut and Washers.

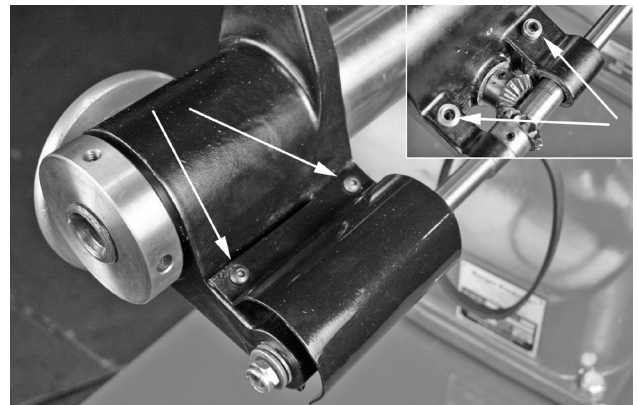

5. Loosen the Allen Set Screw on the one Drum Feed Gear.



9. Remove the old Belt.



6. Remove the Spindle End Nut with the Spanner Wrench. Watch for the Bearing as the End Nut becomes loose. Remove the Bearing.

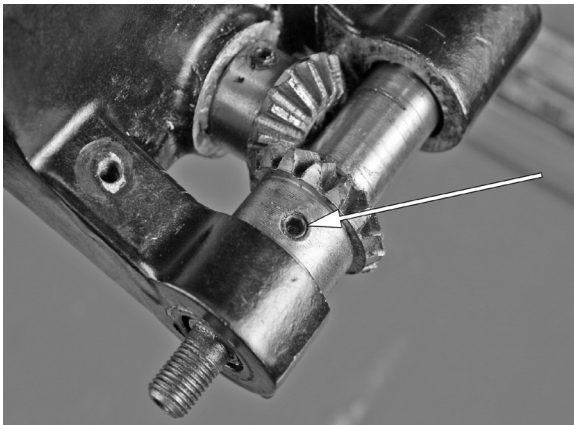

10. Install the new Belt.

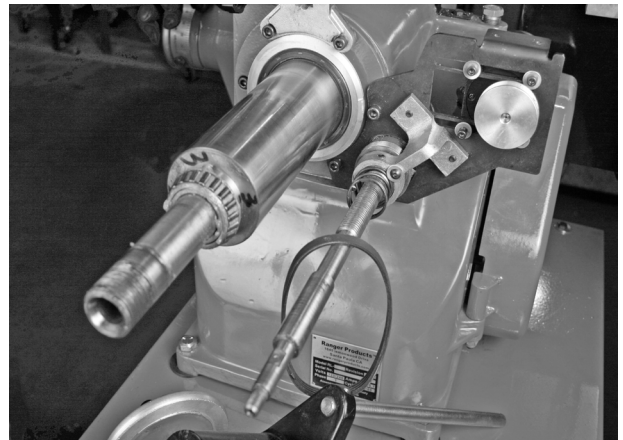

7. Loosen the Spindle Feed Lock.



Prior to Reassembly:

NOTE:

Take this time to inspect and repack the bearings with grease prior to Reassembly.

NOTE:

DO NOT tighten the Drum Feed Lock Screw all the way. Back off the Nylock Nut a quarter to half turn from tight to allow the gears to turn. Test by for proper operation by turning the Spindle Feed hand wheel.

Reassembly is the reverse of the above procedures.

8. Slide the Feed Bracket Assembly off the Spindle. Cup your hand under the Gears and Washers to prevent them from falling.

STEP 21 (Maintenance)

Read and follow all the maintenance instructions provided in this manual to keep the lathe in good operating condition. Regular inspections and proper maintenance are essential to preventing accidents and injuries. These instructions will help you service the unit. Instructions are for a person with some mechanical ability and training. No attempt has been made to describe all basic steps like how to loosen or tighten fasteners. Basic procedures such as cycling systems and checking operation of the equipment are not fully described since they are described in this manual. Do not attempt to perform work beyond your ability or at which you have no experience. If you need assistance, call an authorized service center or contact the factory.



◆ Before making any inspection, adjustment, or repair, disconnect the power source and lock out all moving parts to prevent injury.

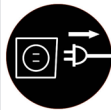

◆ Keep the machine and the immediate work area clean. Do not use compressed air to remove dirt and debris from the lathe. Chips and dust may be driven between machined parts and into bearings causing undue wear and foreign material may be propelled into the air and into operator or bystander causing personal injury.

◆ Wear protective clothing and use eye protection when making any adjustments or repairs to the machine.



◆ Check for worn, damaged or missing parts including grips and protective covers. Replace them before allowing the unit to be used.

◆ Make sure all fasteners are securely tightened and all guards and covers are in place.

◆ Replace any damaged or missing safety decal's. They are available from the factory.

◆ On a daily basis, inspect the unit and check to be certain that all systems are operating normally. Follow detailed inspection and testing procedures for various components at regular intervals.

USE ONLY RANGER ORIGINAL OR AUTHORIZED SERVICE PARTS TO INSURE SAFETY AND PERFORMANCE.

Daily:

◆ Check the Oil level using the sight Glass Fill as necessary using 80/90 gear oil.

◆ All Adapters should be kept clean and free of nicks or burs. WD-40 or equivalent works well as a cleaning medium and rust preventer.

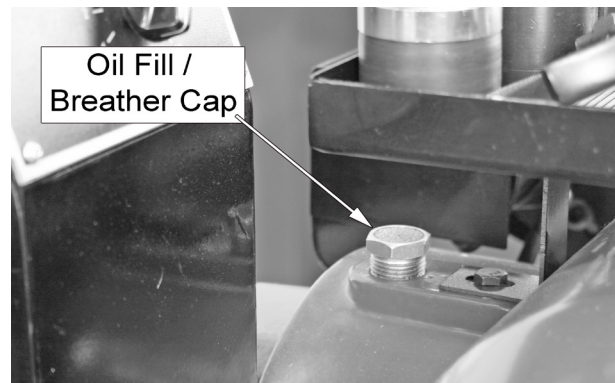
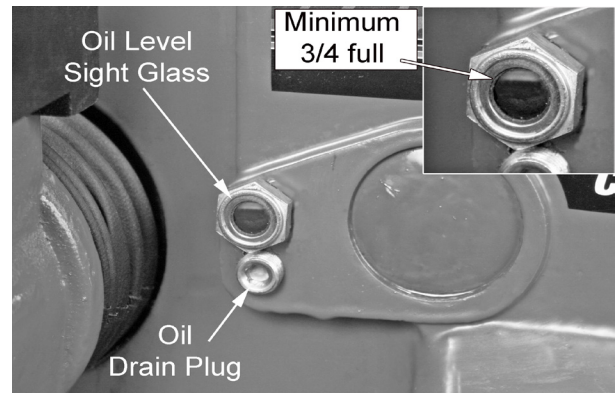

◆ Keep the arbor free of any foreign material on every setup.

◆ Keep the surfaces in the slot where the tool bit holder mounts free of chips and burs. Keep the bottom of the tool bit holder free of burs.

◆ All exposed machine surfaces of the lathe should be brushed clean and wiped with WD-40 or Equivalent.



DO NOT BLOW THE MACHINE WITH COMPRESSED AIR!

Chips and dust may be driven between machined parts and into bearings, causing undue wear. They may also contact persons in the area causing personal injury.

MONTHLY:

◆ Lubricate the Cross Feed Assembly by pumping grease into the fitting until it will not accept any more grease.

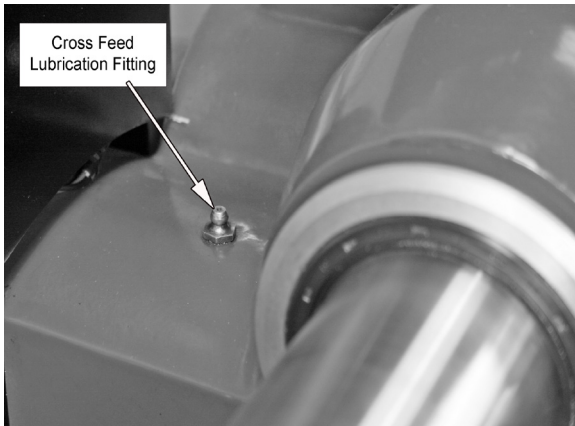

NOTE:

IN HIGH VOLUME APPLICATIONS LUBRICATE THE CROSS FEED ON A WEEKLY BASIS

◆ Check all screws and fasteners, tighten as needed.

ANNUALLY:

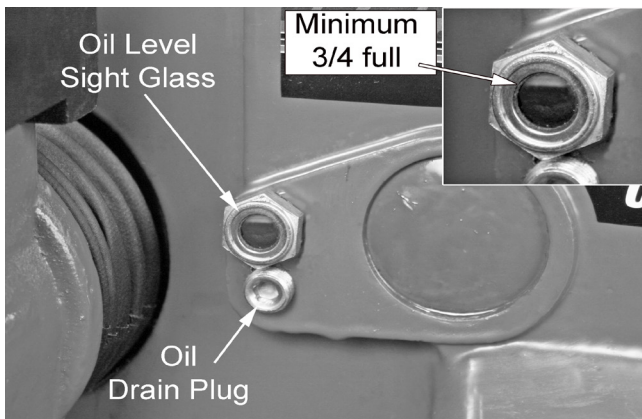

Change the Lubricant in the housing.

NOTE:

Ensure that the lathe is free of chips and any metal shavings before opening the Oil Fill / Breather Cap.



1. Place an oil catch container below the Oil Drain Plug.
2. Remove the Oil Drain Plug with an Allen Wrench



3. Drain oil into appropriate container and dispose of or recycle in accordance with local environmental provisions.
4. Replace the Drain Plug and tighten.
5. Remove the Oil Fill / Breather Cap.

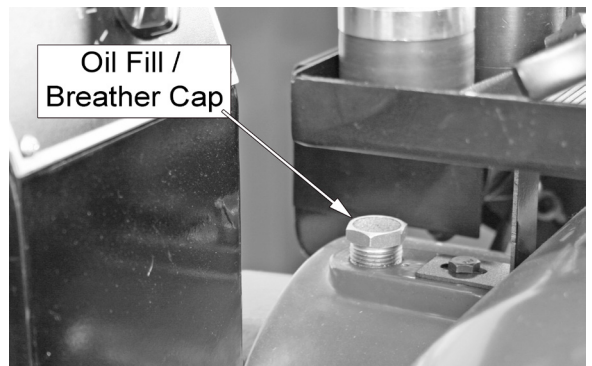

6. Fill the housing with 80/90W gear oil until the oil is approximately 3/4 full when viewed on the Oil Sight Glass.

Labels

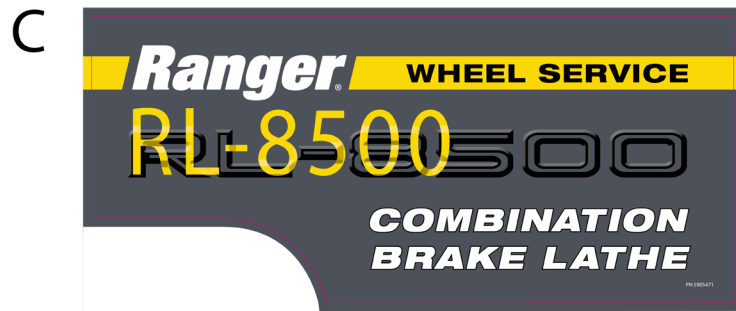

PN 5906071

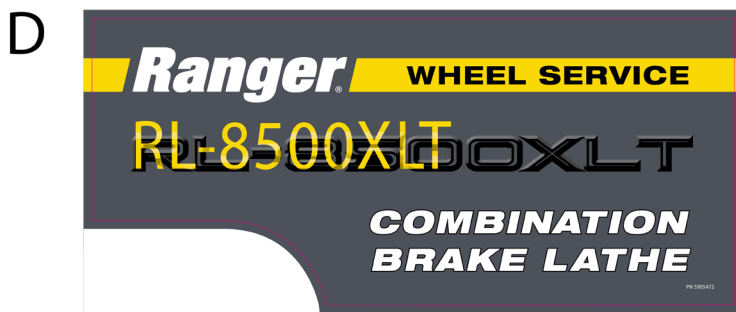

E

<p>⚠ WARNING</p>	<p>For Best Results Always Use Ranger Tool Bits and Accessories. Call Your Distributor or Call 1-800-253-2363</p>
<ol style="list-style-type: none"> 1. Protective goggles, safety glasses or a face shield must be provided by the purchaser/user and worn by the operator of the equipment. Make sure all eye and face safety precautions are followed by the operator(s). Keep bystanders out of the area. 2. Do not remove any safety equipment, belts guards or bypass controls or operations. 3. Make sure drums and rotors are properly and squarely mounted before starting the lathe. Check that all parts are secure. 4. Do not wear loose clothing, jewelry or gloves when operating or working around the lathe. 5. Do not overload the lathe. Read and understand the lathe capabilities. Overloading or exceeding the limits of the lathe will shorten its lifespan. 6. Improper use can cause a failure resulting in personal injury. 7. Unplug the unit from the power source before servicing or adjusting. 8. Maintain the unit properly. Keep work surfaces and work area clean. 	<p><small>PN 5906073</small></p>

PN 5906073

F

⚠ DANGER ⚠

Before using this brake lathe, **ALWAYS** assume that all brake rotors, brake drums, and flywheels have residual asbestos particles that may become airborne. Exposure to asbestos, if not properly controlled can cause lung disease and mesothelioma, a cancer of the lining of the lung or stomach that is nearly always fatal. Failure to utilize proper brake dust control procedures may result in increased asbestos exposure. **ALWAYS** ensure that all operators using this equipment wear appropriate personal protective equipment such as, but not limited to: respiratory protective equipment; disposable coveralls or similar full-body disposable work clothing; gloves, head coverings, and foot coverings; and face shields, vented goggles, or other appropriate personal protective equipment.

For more information, visit www.epa.gov and www.osha.gov

Failure to follow these warnings can result in serious injury or death.

PN 5906084

H



I

CALIFORNIA PROPOSITION 65

⚠ WARNING ⚠

WARNING! This product can expose you to chemicals including styrene and vinyl chloride which are on the list of over 900 chemicals identified by the State of California to cause cancer, birth defects or reproductive harm. **ALWAYS** use this product in accordance with the manufacturer's instructions.

For more information, go to www.p65warnings.ca.gov. PN 5905775

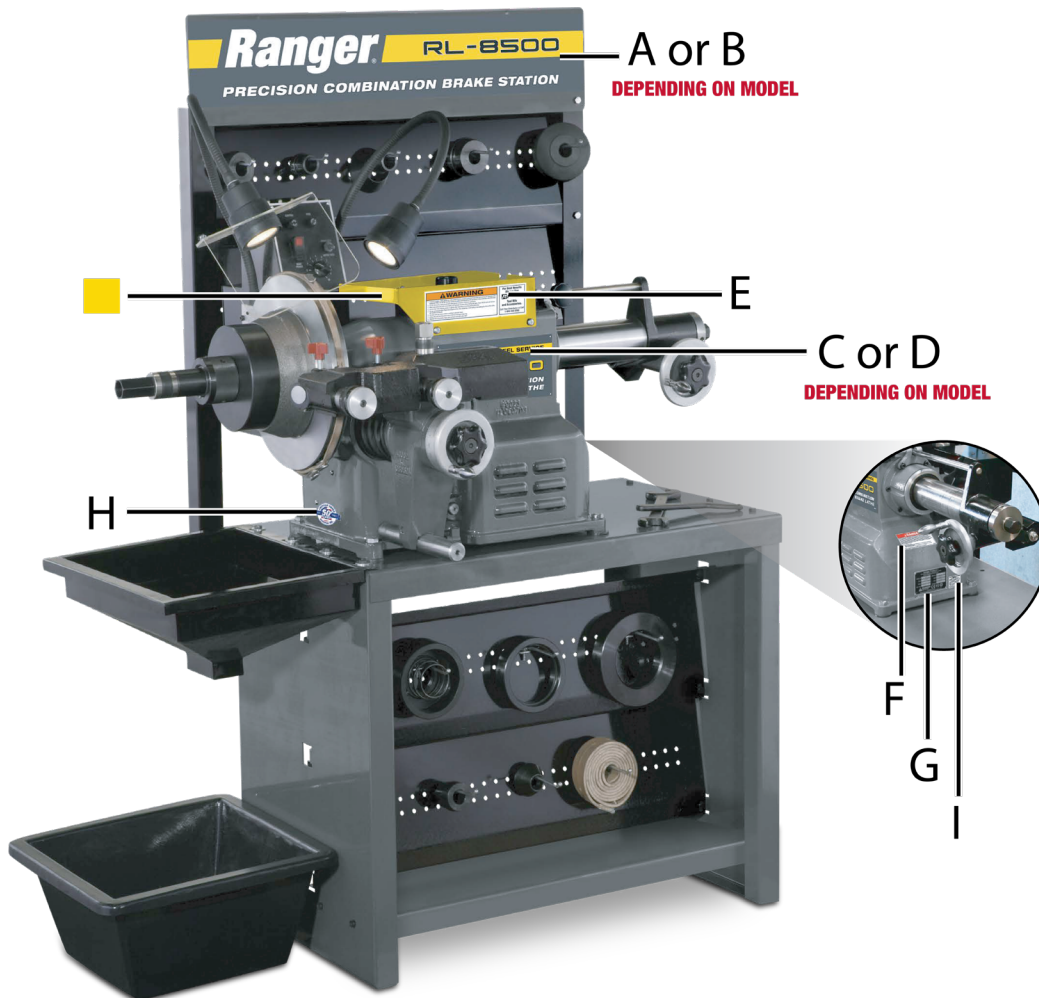

MOTORFEED ASSEMBLY

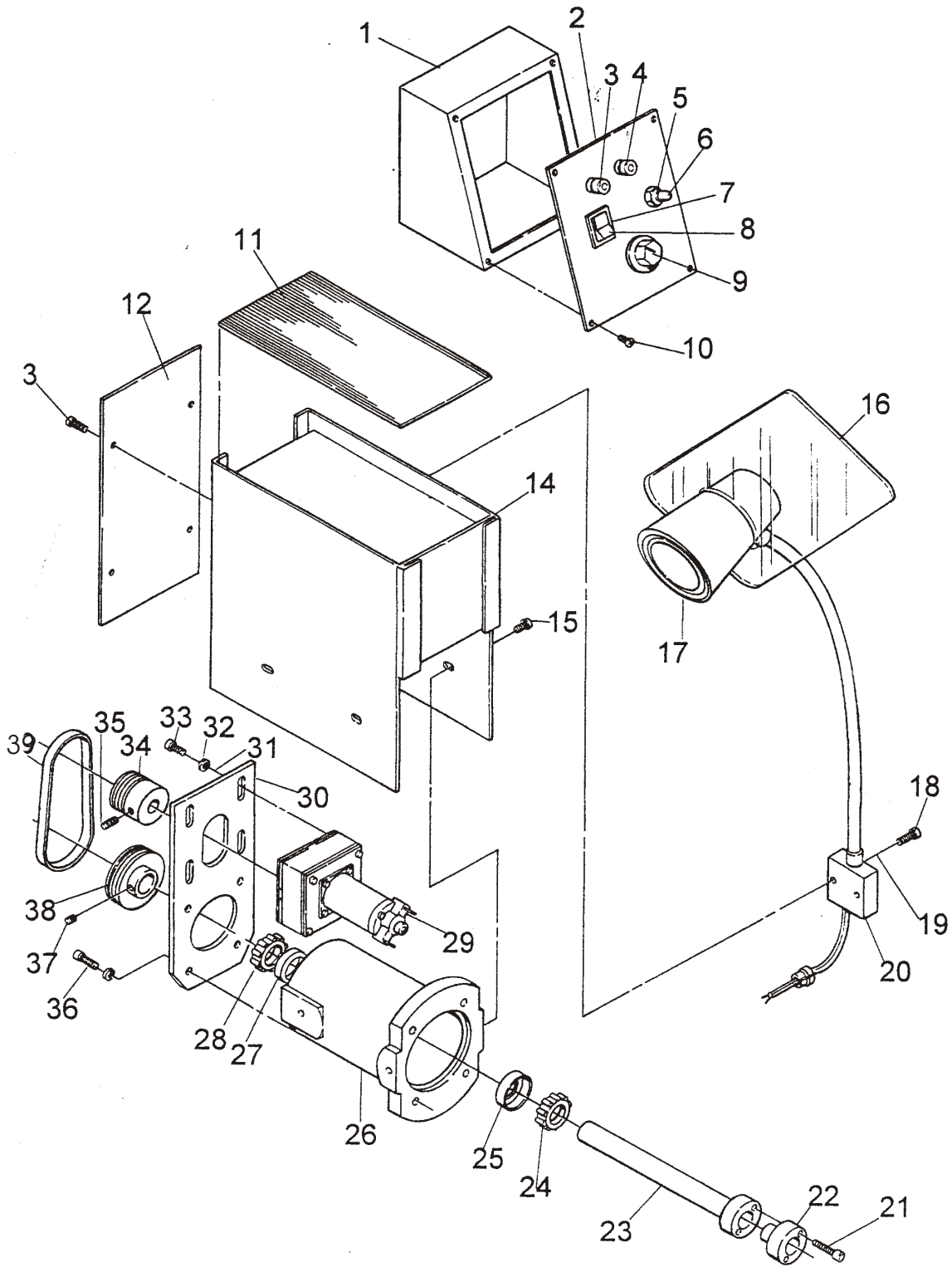

Motor Feed Assembly

	<u>Description</u>	<u>Quantity</u>
1	Electrical Box	1
2	Electrical Box Cover	1
3	Circuit Breaker 1 Amp	1
4	Circuit Breaker 2 Amp	1
5	Toggle Switch	1
6	Toggle Switch Boot	1
7	Rocker Switch	1
8	Lens Cap	1
9	Controller Knob	1
10	Screw	4
11	Vinyl Pad	1
12	Cover Back Panel	1
13	Sheet Metal Screw	4
14	Gear Box Cover	1
15	Screw	3
16	Plastic Shield	1
17	Worklight	1
18	Screw	2
19	Nut	2
20	Light Holder	1
21	Screw	2
22	Leadscrew Nut	1
23	Center Shaft	1
24	Bearing	1
25	Race	1
26	Housing	1
27	Race	1
28	Bearing	1
29	Gear Motor	1
30	Motor Mount Plate	1
31	Fender Washer	4
32	Washer	4
33	Screw	4
34	Small Pulley	1
35	Set Screw	2
36	Screw	4
37	Set Screw	2
38	Large Pulley	1
39	Belt	1
	Power Cord (not pictured)	1
	Cord Grip (not pictured)	1

Drum Feed Assembly

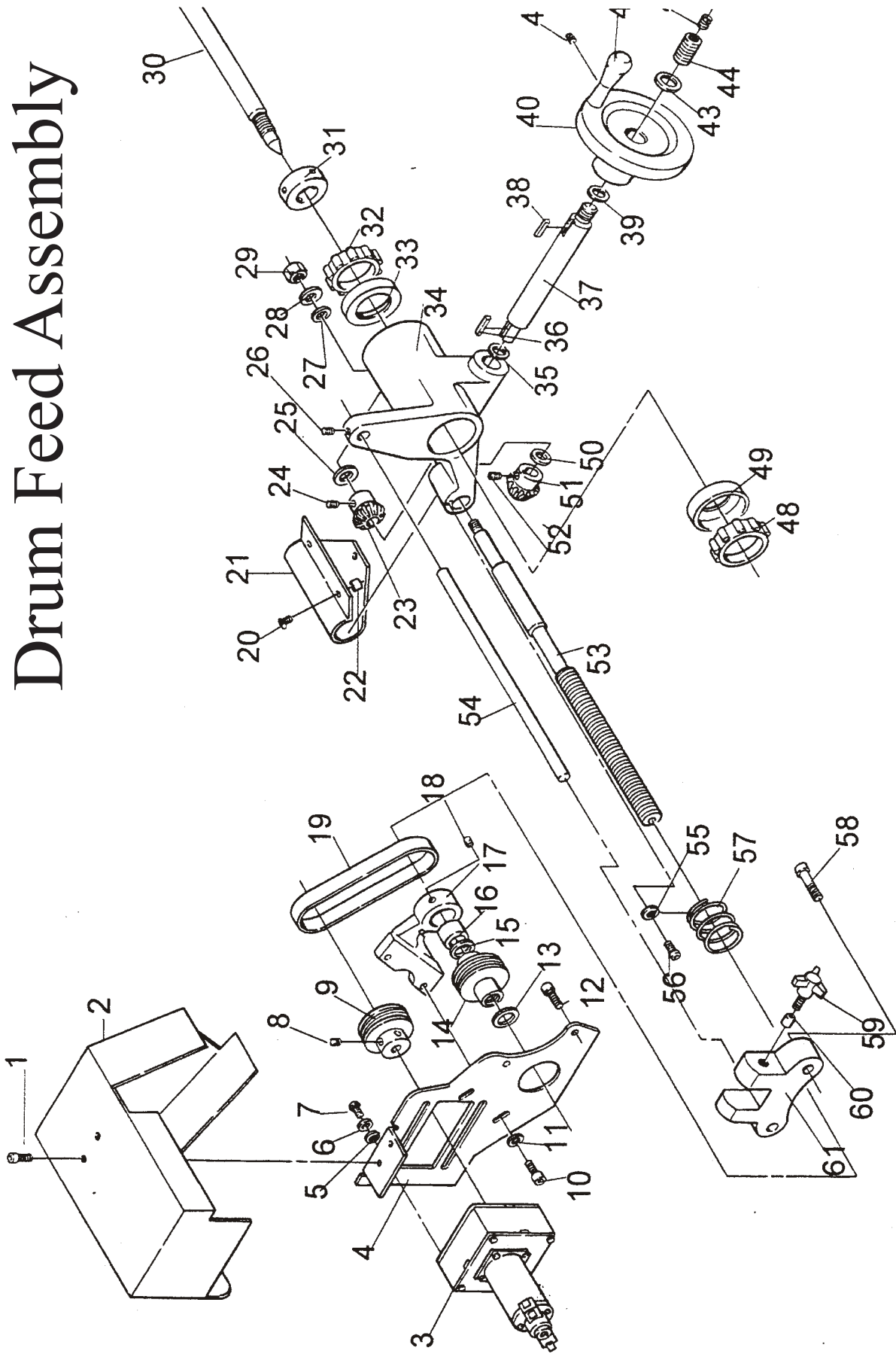

Drum Feed Assembly

	<u>Description</u>	<u>Qty</u>		<u>Description</u>	<u>Qty</u>
1	Screw	2	32	Bearing	1
2	Drum Feed Cover	1	33	Race	1
3	Gear Motor	1	34	Drum Feed Bracket	1
4	Motor Mount Plate	1	35	Thrust Washer	1
5	Fender Washer	3	36	Key	1
6	Washer	3	37	Gear Rod	1
7	Screw	3	38	Key	1
8	Set Screw	2	39	Thrust Washer	1
9	Pulley	1	40	Handwheel	1
10	Screw	2	41	Screw	1
11	Washer	2	42	Handle	1
12	Screw	2	43	Washer	1
13	Bushing	1	44	Adapter	1
14	Feed Screw Nut	1	45	Set Screw	1
15	Bushing	1	46	Lock Nut	1
16	Bushing	1	47	Screw	1
17	Leadscrew Support	1	48	Bearing	1
18	Set Screw	1	49	Race	1
19	Belt	1	50	Thrust Washer	1
20	Screw	3	51	Miter Gear	1
21	Feed Screw Cover	1	52	Set Screw	1
22	Spacer	2	53	Drum Feed Screw	1
23	Miter Gear	1	54	Lock Rod	1
24	Set Screw	1	55	Washer	1
25	Thrust Washer	1	56	Screw	1
26	Set Screw	1	57	Spring	1
27	Washer	1	58	Screw	2
28	Washer	1	59	Red Knob	1
29	Lock Nut	1	60	Brass Plug	1
30	Drawbar	1	61	Front Clamp	1
31	Nut	1			

Crossfeed Assembly

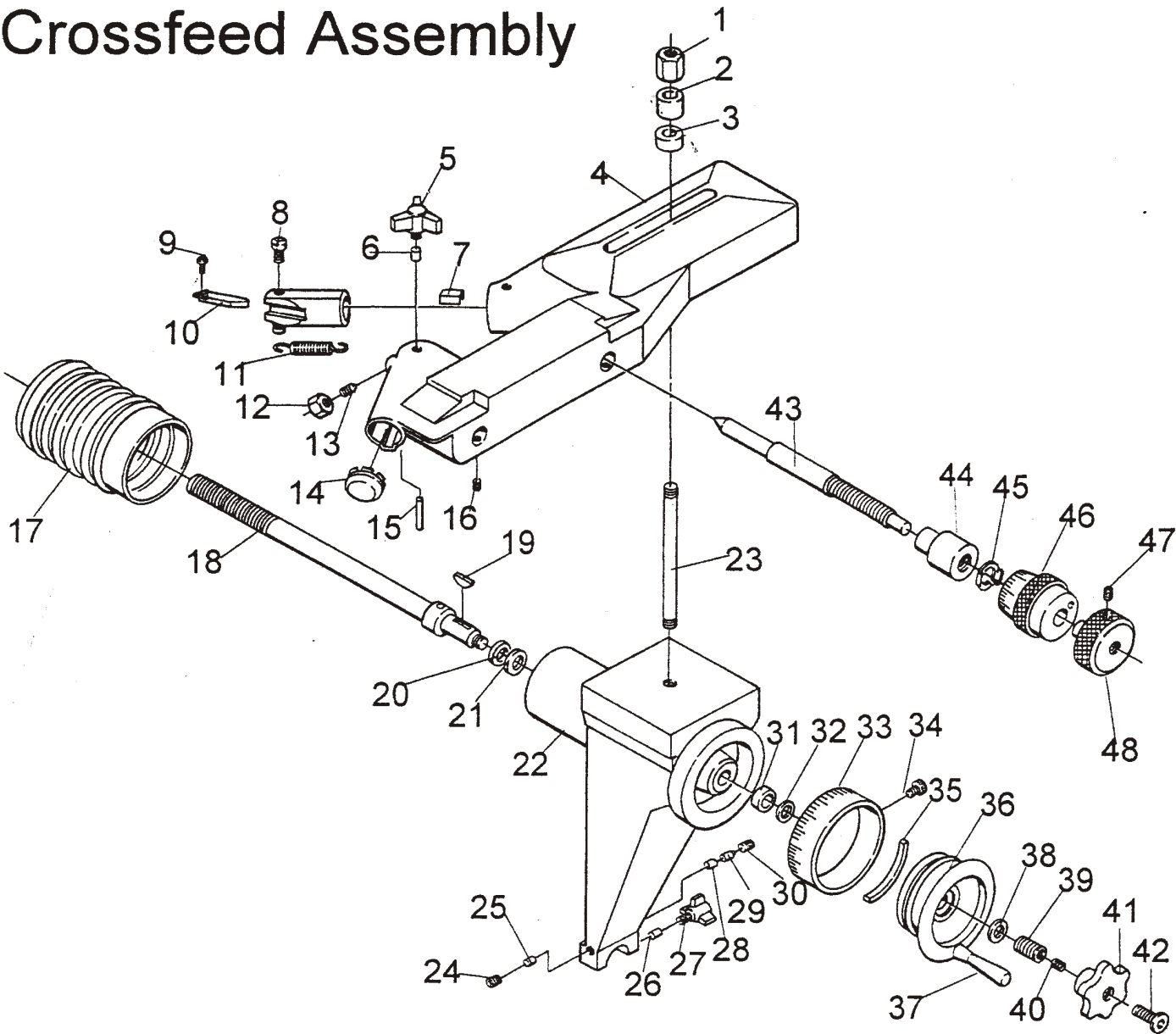

Crossfeed Assembly

Part Number	Description	Quantity
1	Lock Nut	1
2	Retainer	1
3	Spherical Washer	1
4	Twin Cutter Housing	1
5	Red Knob	2
6	Brass Plug	2
7	Spacer	2
8	Square Head Screw	2
9	Insert w/ Screw	2
10	Positive Rake Tool Holder LH	1
	Positive Rake Tool Holder RH	1
11	Spring	2
12	Jam Nut	2
13	Set Screw	2
14	Plug	2
15	Groove Pin	2
16	Set Screw	1
17	Crossfeed Boot	1
18	Leadscrew	1
19	Woodruff Key	1
20	Friction Washer	1
21	Thrust Washer	1
22	Crossfeed	1
23	Stud	1
24	Set Screw	1
25	Brass Plug	1
26	Brass Plug	1
27	Red Knob	1
28	Brass Plug	1
29	Spring	1
30	Set Screw	1
31	Oilite Bushing	1
32	Thrust Washer	2
33	Dial	1
34	Thumb Screw	1
35	Dial Spring	1
36	Handwheel	1
37	Handle	1
38	Washer	1
39	Adapter	1
40	Set Screw	1
41	Lock Nut	1
42	Screw	1
43	Dial Rod	2
44	Plug	2
45	Spring Washer	2
46	Dial Micrometer	2
47	Set Screw	2
48	Dial Rod Knob	2

MAIN MOTOR

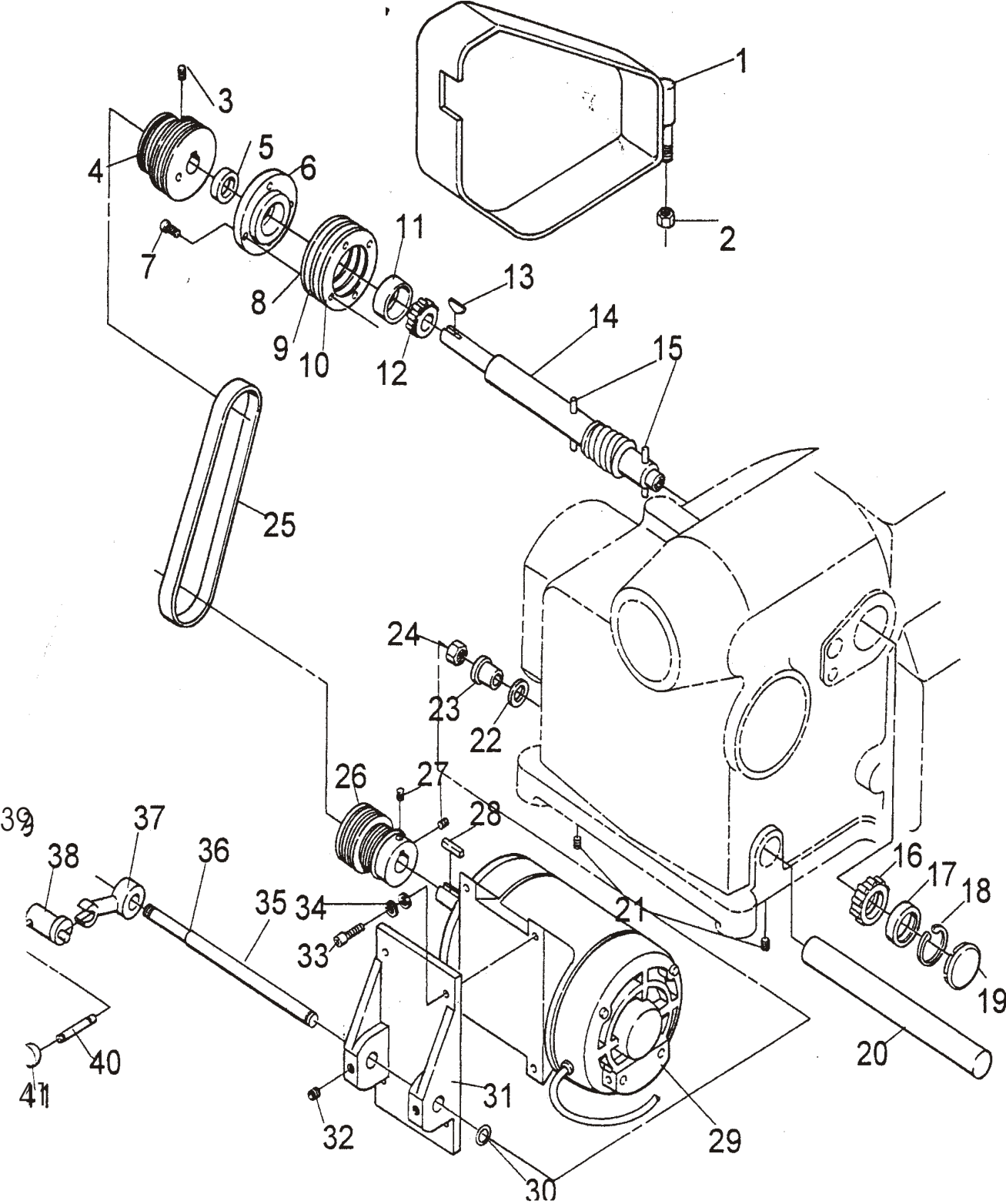

Main Motor Assembly

Part Number	Description	Quantity
1	Belt Guard	1
2	Lock Nut	1
3	Set Screw	2
4	Pulley	1
5	Oil Seal	1
6	Bearing Seal Cap	1
7	Screw	4
8	Shim	1
9	Shim	1
10	Shim	1
11	Race	1
12	Bearing	1
13	Woodruff Key	1
14	Drive Shaft	1
15	Roll Pin	2
16	Bearing	1
17	Race	1
18	Retaining Ring	1
19	Freeze Plug	1
20	Guide Bar	1
21	Set Screw	2
22	O-Ring	1
23	Bushing	1
24	Hex Nut	1
25	Belt	1
26	Pulley	1
27	Set Screw	2
28	Key	1
29	Main Motor	1
30	O-Ring	1
31	Motor Mount Bracket	1
32	Set Screw	2
33	Bolt	4
34	Lock Washer	4
35	Motor Mount Shaft	1
36	O-Ring	1
37	Belt Tension Lever	1
38	Belt Release Pin	1
39	Set Screw	1
40	Belt Release Handle	1
41	Red Knob	1

Spindle Assembly

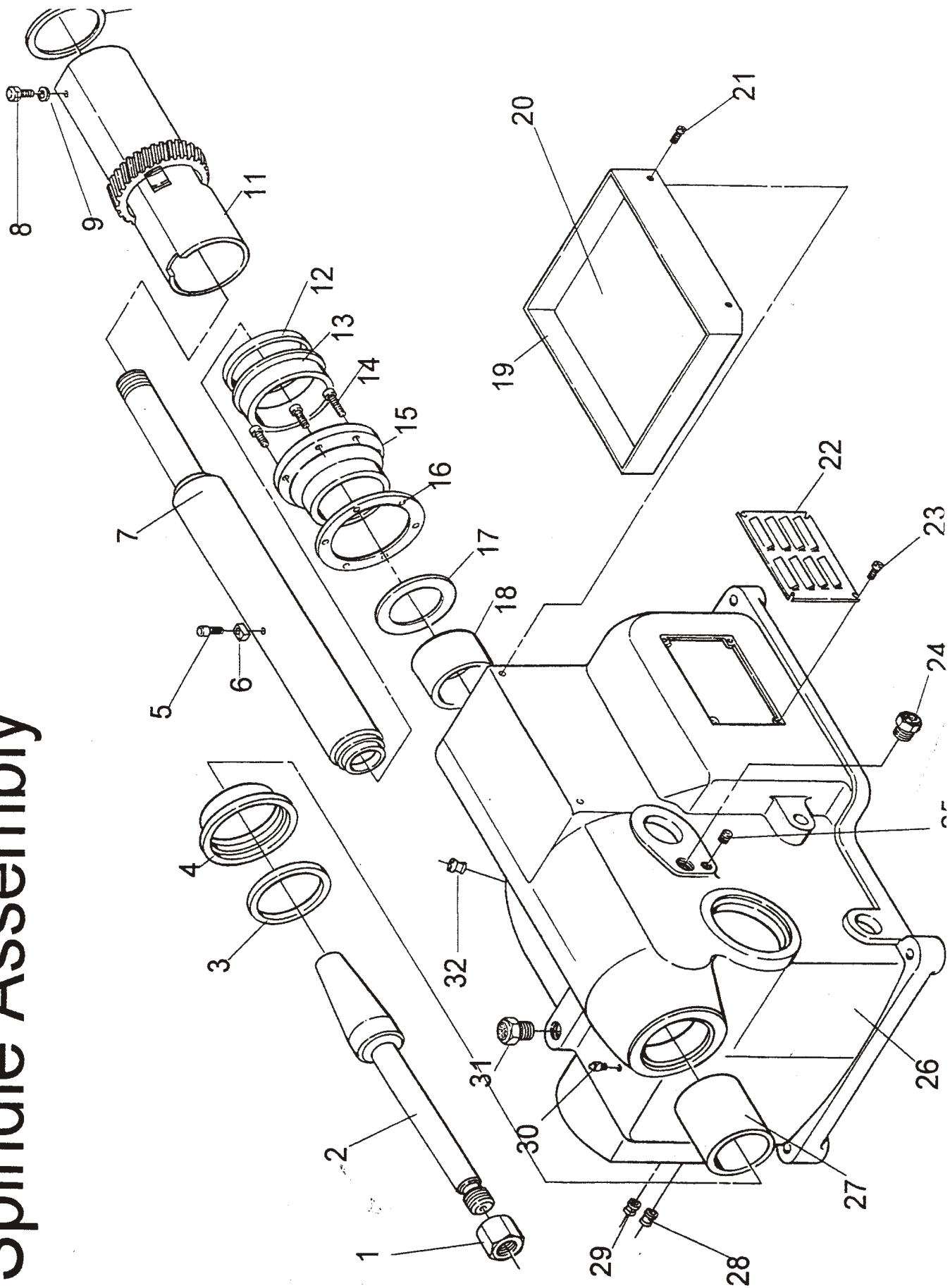

Spindle Assembly

Part Number	Description	Quantity
1	Arbor Nut	1
2	Arbor	1
3	Oil Seal	1
4	Oil Seal Adapter Ring	1
5	Screw	1
6	Drive Key	1
7	Spindle	1
8	Screw	1
9	Lock Washer	1
10	Thrust Washer	1
11	Quill	1
12	Oil Seal	1
13	Oil Seal Adapter Ring	1
14	Screw	2
15	Rear Flange	1
16	Shim	3
17	Thrust Washer	1
18	Bronze Bushing	1
19	Tool Tray	1
20	Vinyl Mat	1
21	Screw	3
22	Louver	1
23	Screw	4
24	View Oil Gage	1
25	Plug	1
26	Main Motor	1
27	Bronze Bushing	1
28	Insulated Bushing	1
29	Insulated Bushing	1
30	Grease Fitting	1
31	Breather Vent	1
32	Insulated Bushing	1



The Benchmark of Quality

**FOR PARTS OR SERVICE
CONTACT:**

**BendPak Inc. / Ranger Products
1645 Lemonwood Dr.
Santa Paula, CA. 93060**

**Tel: 1-805-933-9970
Fax: 1-805-933-9160**

**www.bendpak.com
www.rangerproducts.com**

